

**AED DEFIBRILLATOR  
WALL CABINET**

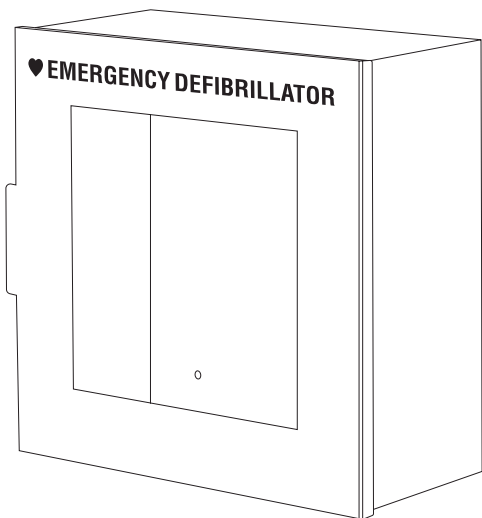

**USER GUIDE**

**SKU: ADI999-01**



# Thank you for your purchase.



**Viva Essentials maintains  
a strong practice of ongoing  
development of products  
and commercial research.**



We recognize that starting and maintaining a medical practice is expensive. We'll help make the process cost-effective and elegant. Additionally, our team of specialists will ensure everything you need works as efficiently as possible, so you can effectively treat your clients.

# Table of Contents

- 2 Parts List
- 3 Tools Needed (Not Included)
- 4 Assembly Instructions
- 6 Warranty
- 7 Notes

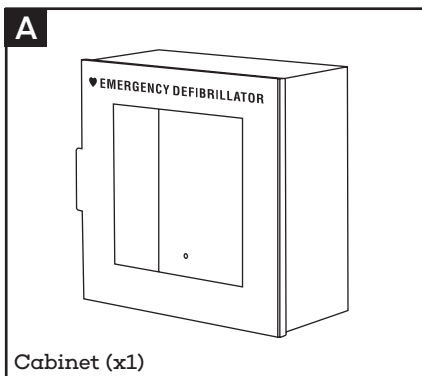

# Parts List

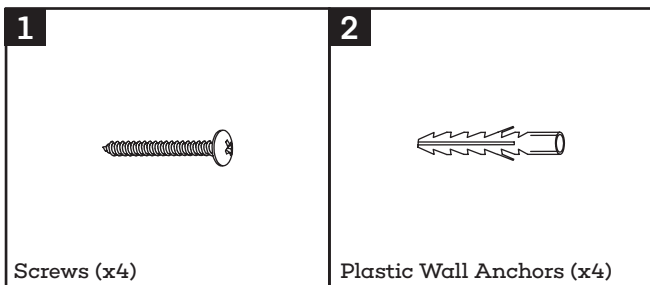

# Hardware List

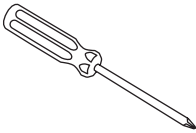
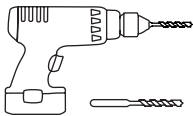

## Tools Needed (Not Included)

 <p>Phillips Screwdriver</p>	 <p>Drill &amp; Drill Bit</p>	 <p>Pencil</p>
---	--	---

## Specifications

**Product Dimensions:** 15" H x 15" W x 7"D

**Weight:** 8 lbs.

# Assembly Instructions

## Step 1:

- A.** There are four holes located inside your Cabinet (A).
  - B.** Place your Cabinet (A) where you want to install it. Using a pencil, mark each hole's location on the wall.
  - C.** Remove the Cabinet (A) from the wall.
    - a.** In the marked locations, drill a hole large enough for the Plastic Wall Anchors (2), but don't drill it too large.
  - D.** Using a Phillips screwdriver, twist each Plastic Wall Anchors (2) into the wall.
- 

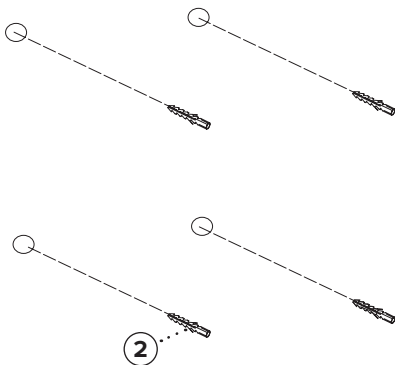

# Assembly Instructions

## Step 2:

- A.** Line the Cabinet (A) up to the holes, and insert four Screws (1) through the back of the Cabinet (A) and into the holes in the wall.
- a.** Hand tightening is recommended with a Philips head screwdriver.
- b.** Using a drill could damage the hole, and risk stripping the Screws (1)
- B.** Your AED Defibrillator Wall Cabinet is now ready to be used.

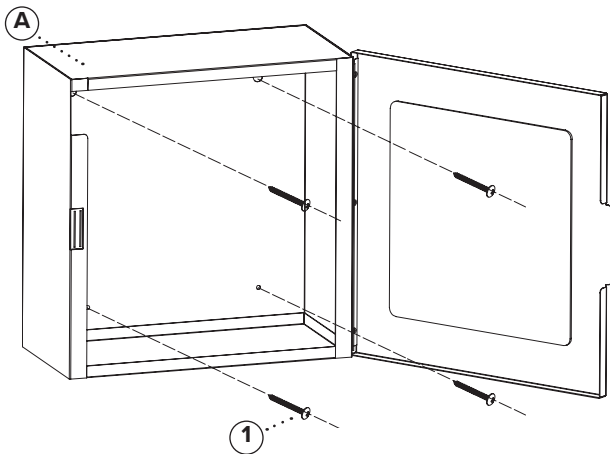

# Warranty

1. Viva Essentials (the "Company" or "Tiger Companies") warrants to the purchaser that the product will be free from defects in workmanship and materials for a period of 1 year from the date of purchase. The warranty period is not extended if we repair, replace, exchange, or provide a refund for the product (as determined in our sole discretion). We may change the availability of this limited warranty at our discretion, but any changes will not be retroactive.
2. These warranties are not assignable or transferable to any other person, including, without limitation, any subsequent owner or other transferee of the product.
3. This Warranty does not apply to: (a) damage caused by misuse, tampering, abuse, neglect, or accident; (b) damage caused by improper installation, modification, or service; (c) alteration of the serial number; or (d) use that violates the instructions furnished by the Company will void this warranty.
4. The sole responsibility of the Company shall be limited to (a) the repair or replacement (in its sole discretion) of any component of the product which fails to conform to this; (b) a refund the purchase price of such product (in its sole discretion), at no cost to the purchaser for the period of the warranty, or (c) an exchange for a similar product, comparable in function and price.
5. Contact the Company directly at 1-(800)-805-1790 to obtain service under this warranty. If it becomes applicable to send a defective product to the Company, a Return Authorization Number must first be obtained from the Company. In order to obtain service under this warranty, purchaser may be required to provide the Company with the following items (a) proof of purchase, (b) photographs and or videos (of the damage, and (c) a written testimonial describing the defect.
6. Products shipped without prior Return Authorization and Return Authorization Number may not be accepted, and the Company will not be responsible for their disposition and/or cost of return to the owner.
7. The Company will not assume any responsibility for any loss or damage incurred in shipping and or delivery.
8. The product(s) must be returned within 14 calendar days of receiving the return authorization from the Company and must include the original proof of purchase for the warranty to be honored.
9. Any implied warranties that the purchaser may have are limited to the duration of the warranties described above. There are no further warranties that extend or apply beyond the face hereof, and the Company expressly disclaims and excludes any and all warranties of merchantability or fitness for a particular purpose. Some states do not allow limitations on how long an implied warranty lasts, so the above limitation may not apply to you.
10. THE REMEDIES DESCRIBED ABOVE ARE YOUR SOLE AND EXCLUSIVE REMEDIES AND THE COMPANY'S ENTIRE LIABILITY FOR ANY BREACH OF THIS LIMITED WARRANTY. OUR LIABILITY SHALL UNDER NO CIRCUMSTANCES EXCEED THE ACTUAL AMOUNT PAID BY YOU FOR THE DEFECTIVE PRODUCT, NOR SHALL WE UNDER ANY CIRCUMSTANCES BE LIABLE FOR ANY CONSEQUENTIAL, INCIDENTAL, SPECIAL OR PUNITIVE DAMAGES OR LOSSES, WHETHER DIRECT OR INDIRECT. SOME STATES DO NOT ALLOW THE EXCLUSION OR LIMITATIONS OF INCIDENTAL OR CONSEQUENTIAL DAMAGES, SO THE LIMITATION MAY NOT APPLY TO YOU.
11. This warranty gives you specific legal rights, and you may also have additional rights which vary from state to state.



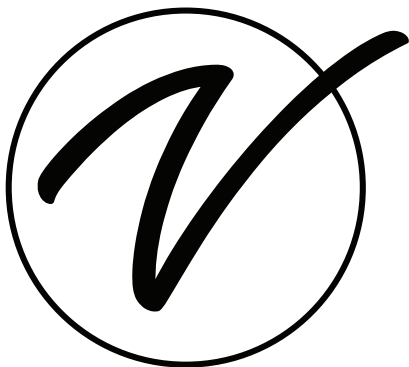

**SKU ADI999-01**

© 2025 Viva Essentials

**vivacomfort.com**