

.....

ALUMINUM PORTABLE HEIGHT MEASURING ROD FOR ADULTS AND CHILDREN, WITH CARRYING BAG

.....

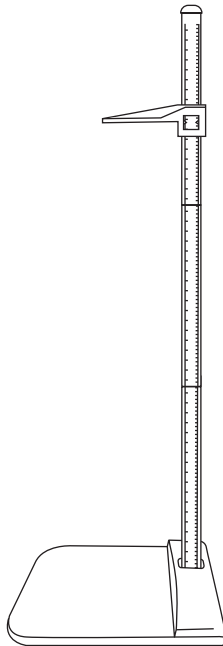

USER GUIDE

ADIME907-01



Thank you for your purchase.



Viva Comfort maintains a strong practice of ongoing development of products and commercial research.



We recognize that starting and maintaining a medical practice is expensive. We'll help make the process cost-effective and elegant. Additionally, our team of specialists will ensure everything you need works as efficiently as possible, so you can effectively treat your clients.

Table of Contents

- 2 Parts List
- 3 Assembly Instructions
- 7 Disassembly Instructions
- 8 Warranty
- 9 Notes

Parts List

A

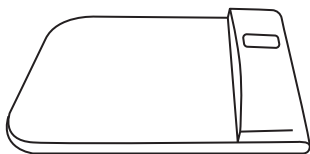

Base

B



Height Measuring
Sliding Baffle

C

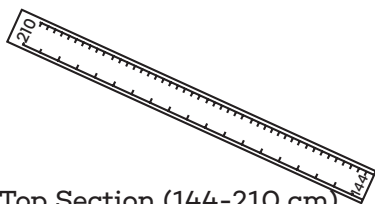

Top Section (144-210 cm)

D

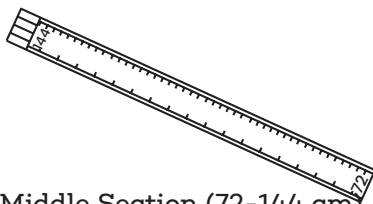

Middle Section (72-144 cm)

E

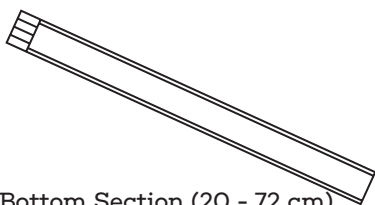

Bottom Section (20 - 72 cm)

F



Top Cover
(Preinstalled)

Tools Needed (But Not Included)

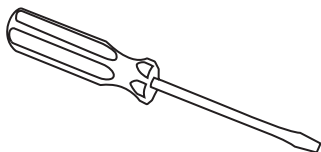

Flat Head Screwdriver

Assembly Instructions

Step 1:

- A.** Before assembling the height rod sections, you must remove two metal tabs on the inside of each section.
- B.** This can be accomplished by taking a flat-head screwdriver, inserting it into the slit on each side of the section, as pictured, and pushing the metal tab up.
 - a.** The tabs should both pop out very quickly.

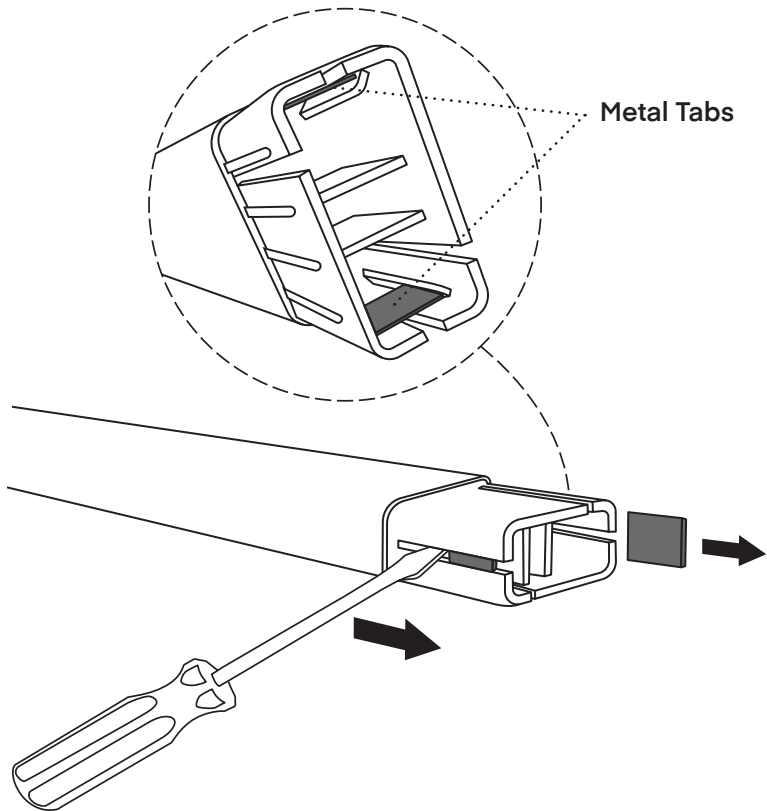

Step 2:

- A.** Next, locate the Height Measuring Sliding Baffle (B) and slide it over the Top Section (C).
- a.** To do this slide it upward from the bottom, not from the top portion where the Top Cover (F) is.
- b.** Place the Top Section (C) on the floor after you put the Height Measuring Sliding Baffle (B) over it.

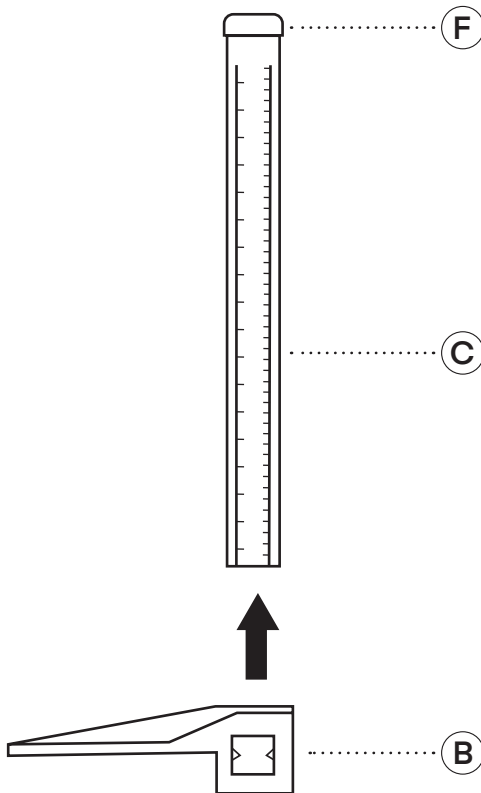

Step 3:

- A. Locate the Middle Section (D), and attach the Top Section (C) to it.
 - a. Push them together until they're flush with one another.
- B. Next, attach the Middle Section (D) to the Bottom Section (E).
 - a. Push them together until they're flush with one another.

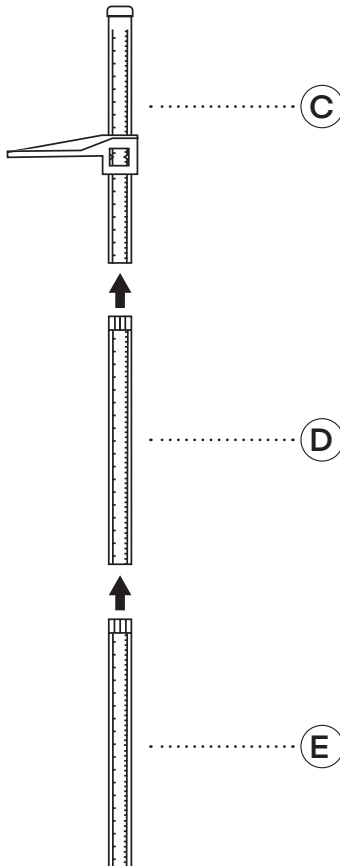

Step 4:

- A. Insert the assembled height rod into the slot on the Base (A), until secured.

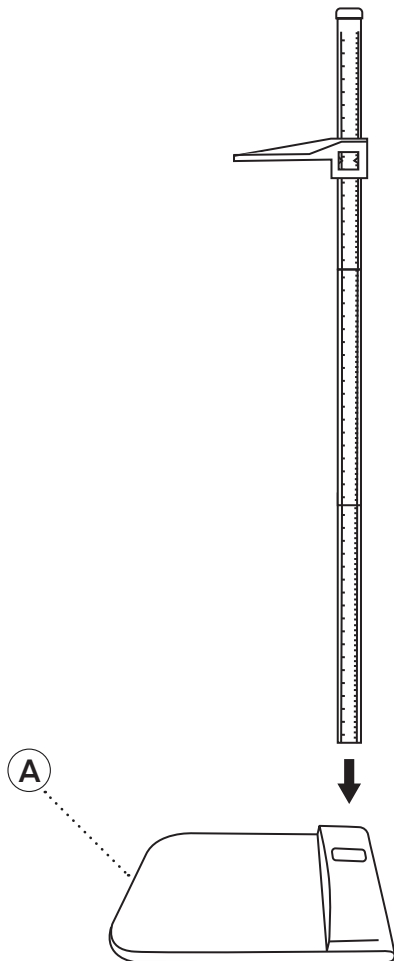

Disassembly Instructions

Step 1:

- A. Take the assembled height rod out of the Base (A).

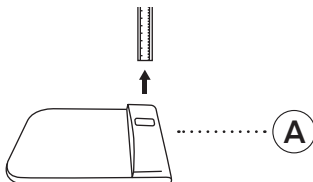

Step 2:

- A. Disconnect all the different sections of the height rod.

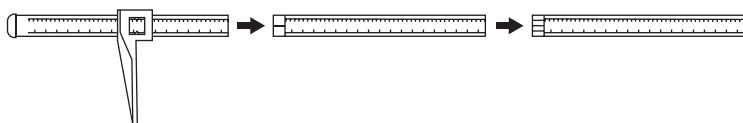

Step 3:

- A. Remove the Height Measuring Sliding Baffle (B).

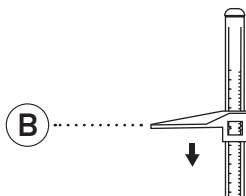

Step 4:

- A. Place all five pieces in the included carrying bag for easy transportation.

Warranty

1. Viva Comfort (the "Company" or "Tiger Companies") warrants to the purchaser that the product will be free from defects in workmanship and materials for a period of 1 year from the date of purchase. The warranty period is not extended if we repair, replace, exchange, or provide a refund for the product (as determined in our sole discretion). We may change the availability of this limited warranty at our discretion, but any changes will not be retroactive.
2. These warranties are not assignable or transferable to any other person, including, without limitation, any subsequent owner or other transferee of the product.
3. This Warranty does not apply to: (a) damage caused by misuse, tampering, abuse, neglect, or accident; (b) damage caused by improper installation, modification, or service; (c) alteration of the serial number; or (d) use that violates the instructions furnished by the Company will void this warranty.
4. The sole responsibility of the Company shall be limited to (a) the repair or replacement (in its sole discretion) of any component of the product which fails to conform to this; (b) a refund the purchase price of such product (in its sole discretion), at no cost to the purchaser for the period of the warranty, or (c) an exchange for a similar product, comparable in function and price.
5. Contact the Company directly at 1-(800)-805-1790 to obtain service under this warranty. If it becomes applicable to send a defective product to the Company, a Return Authorization Number must first be obtained from the Company. In order to obtain service under this warranty, purchaser may be required to provide the Company with the following items (a) proof of purchase, (b) photographs and or videos (of the damage, and (c) a written testimonial describing the defect.
6. Products shipped without prior Return Authorization and Return Authorization Number may not be accepted, and the Company will not be responsible for their disposition and/or cost of return to the owner.
7. The Company will not assume any responsibility for any loss or damage incurred in shipping and or delivery.
8. The product(s) must be returned within 14 calendar days of receiving the return authorization from the Company and must include the original proof of purchase for the warranty to be honored.
9. Any implied warranties that the purchaser may have are limited to the duration of the warranties described above. There are no further warranties that extend or apply beyond the face hereof, and the Company expressly disclaims and excludes any and all warranties of merchantability or fitness for a particular purpose. Some states do not allow limitations on how long an implied warranty lasts, so the above limitation may not apply to you.
10. THE REMEDIES DESCRIBED ABOVE ARE YOUR SOLE AND EXCLUSIVE REMEDIES AND THE COMPANY'S ENTIRE LIABILITY FOR ANY BREACH OF THIS LIMITED WARRANTY. OUR LIABILITY SHALL UNDER NO CIRCUMSTANCES EXCEED THE ACTUAL AMOUNT PAID BY YOU FOR THE DEFECTIVE PRODUCT, NOR SHALL WE UNDER ANY CIRCUMSTANCES BE LIABLE FOR ANY CONSEQUENTIAL, INCIDENTAL, SPECIAL OR PUNITIVE DAMAGES OR LOSSES, WHETHER DIRECT OR INDIRECT. SOME STATES DO NOT ALLOW THE EXCLUSION OR LIMITATIONS OF INCIDENTAL OR CONSEQUENTIAL DAMAGES, SO THE LIMITATION MAY NOT APPLY TO YOU.
11. This warranty gives you specific legal rights, and you may also have additional rights which vary from state to state.



ADIME907-01

© 2024 Viva Comfort

vivacomfort.com