



**Q4 2024**

# **PRODUCT CATALOG**



# LEADING THE WAY IN HEALTHCARE SOLUTIONS

At Viva Comfort, we are the vanguards of contemporary medical equipment, bridging critical gaps in the industry with our innovative and modern solutions.

Our cutting-edge solutions set new standards for design, comfort, and care, and redefine the essence of patient-centric healthcare. Embrace a revolution in luxury with Viva Comfort, where excellence, durability, and innovation provide unparalleled medical solutions.



*Viva*  
COMFORT

# PRODUCT CATEGORIES

**3** Pointe Exam Tables

---

**6** Grande Exam Tables

---

**11** Noble-Line Treatment Tables

---

**17** Regal-Line Rehab Tables

---

**19** Elite-Line Power Treatment Tables

---

**26** Imaging Power Table

---

**30** Physical Therapy Equipment

---

**34** Carts

---

**38** Exam Room Cabinets

---

# PRODUCT CATEGORIES

**49** Medical Scales

---

**59** Exam Stools

---

**62** Blood Drawing Chairs

---

**67** Height Measuring Rods

---

**69** Glove Dispensers

---

**74** Sharps & Needle Disposal Containers

---

**80** Pill Crusher

---

**82** Exam Room Packages

---

# POINTE EXAM TABLES



# POINTE POWER EXAM TABLE

- Dimensions:  
55.12" L X 28.35" W X 18.11" – 33.46" H
- Overall Length with Footrest: 72.12" L
- Mattress Dimensions: 2" H X 28" W X 58" L
- Weight Capacity: 450 lb
- Input 24-29VDC max: 4.8A
- Max load: Push 6000N
- Duty cycle: 10% Max.2 min operate/18min stop

- Compliant with ADA Standards
- Adjustable back and seat sections
- Handheld remote and foot pedal for electric height adjustment
- Enhance adaptability with a gas spring-controlled backrest
- Manual-controlled seat rest
- Pull-out leg rest
- Accessible paper roll dispenser
- Front-facing storage drawer
- Additional storage space behind the backrest
- Easy-to-clean pull-out basin
- Antimicrobial upholstery



**BLACK**

# ADI996-10-BLK



**MIDNIGHT EXPRESS**

# ADI996-10-BLU

**Angle  
Adjustment range:**  
0° ~ 70°

**Height  
Adjustment range:**  
18.11" – 33.46"



**Pull-Out Basin**  
12" L x 9.5" W



**Storage Drawer**  
12" L x 16.75" W x 4" H



6

# GRANDE EXAM TABLES





# GRANDE STEEL EXAM TABLE

**With Mattress**

- Base Dimensions: 29" H X 27" W X 48" L
- Length with Leg Rest Extended: 72" L
- Mattress Dimensions: 2" H X 28" W X 58" L
- Total Weight: 200 lb

- Adjustable backrest
- Pull-out step stool
- Dual-sided cabinet
- Stirrups with contoured heel cups (sold separately)
- Includes paper roll dispenser and paper cutter
- Storage space for paper rolls under the mattress
- Stainless-steel frame for longevity and easy cleaning
- Antimicrobial mattress provides a hygienic environment
- Two-drawer set gives ample space to hold medical supplies

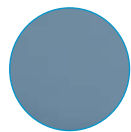

**MIDNIGHT EXPRESS**

# ADI996-09-M-BLU  
*Mattress*



**BLACK**

# ADI996-09-M-BLK  
*Mattress*



*Base*

# ADI996-09-BASE

8 Grande Exam Tables

*Pneumatic Adjustment*



*Two-Storage Shelves*



*Pull-Out Step Stool*

*Stirrups*  
# ADI996-09-SU  
**Sold separately**



*Paper Roll Storage*



# GRANDE STEEL EXAM TABLE

**With Premium Contoured Mattress**

- Premium mattress design conforms to the natural shape of a patient’s body
- Contoured mattress provides pressure relief
- Mattress Dimensions: 2” H X 28” W X 58” L
- Total Weight: 205.75 lb



**BLACK**

# ADI996-09-M2-BLK  
*Premium Mattress*



**MIDNIGHT EXPRESS**



# ADI996-09-M2-BLU  
*Premium Mattress*



*Base*

# ADI996-09-BASE



KIT #	DESCRIPTION	INCLUDED SKUs	COLOR
ADI996-09-S2-BLK	Viva Premium Comfort Grande Series Steel Exam Table	ADI996-09-BASE ADI996-09-M2-BLK	Black 
ADI996-09-S2-BLU	Viva Premium Comfort Grande Series Steel Exam Table	ADI996-09-BASE ADI996-09-M2-BLU	Midn. Exp. 
ADI996-09-S-BLK	Viva Comfort Grande Series Steel Exam Table	ADI996-09-BASE ADI996-09-M-BLK	Black 
ADI996-09-S-BLU	Viva Comfort Grande Series Steel Exam Table	ADI996-09-BASE ADI996-09-M-BLU	Midn. Exp. 

# GRANDE STEEL EXAM TABLE

With Stirrups

- Included stirrups
- Stirrups with contoured heel cup
- Easily foldable when not in use



**BLACK**

# ADI996-09-SSU-BLK  
*Regular Mattress*



**MIDNIGHT EXPRESS**

# ADI996-09-SSU-BLU  
*Regular Mattress*



**BLACK**

# ADI996-09-SSU2-BLK  
*Premium Mattress*



**MIDNIGHT EXPRESS**

# ADI996-09-SSU2-BLU  
*Premium Mattress*



# NOBLE-LINE TREATMENT TABLES



# NOBLE-LINE ADJUSTABLE TREATMENT TABLE

## With Paper Dispenser

- Foldable leg design helps provides space-saving storage
- Stainless-steel frame for longevity and easy cleaning
- Includes paper roll dispenser and paper cutter
- Overall Dimensions: 31.5" H X 27.5" W X 75.5" L
- Total Weight: 60 lb
- Adjustable backrest
- Rubber feet help prevent floor scratches
- Antimicrobial mattress provides a hygienic environment



**BLACK**

# ADI996-01-BLK

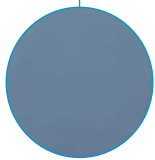

**MIDNIGHT EXPRESS**

# ADI996-01-BLU



### SANITATION

Antimicrobial mattress provides safe and hygienic environment, and reduces the risk of cross-contamination

2-INCH PADDED  
FOAM PU LEATHER  
UPHOLSTERY



**FOLDABLE LEGS**

KIT #	DESCRIPTION	INCLUDED SKU <sub>s</sub>	COLOR
ADI996-01-DR3-BLK	Adjustable Exam Table + Three Drawer Set	ADI996-01-BLK ADI996-01-DR-3	Black 
ADI996-01-DR3-BLU	Adjustable Exam Table + Three Drawer Set	ADI996-01-BLU ADI996-01-DR-3	Blue 

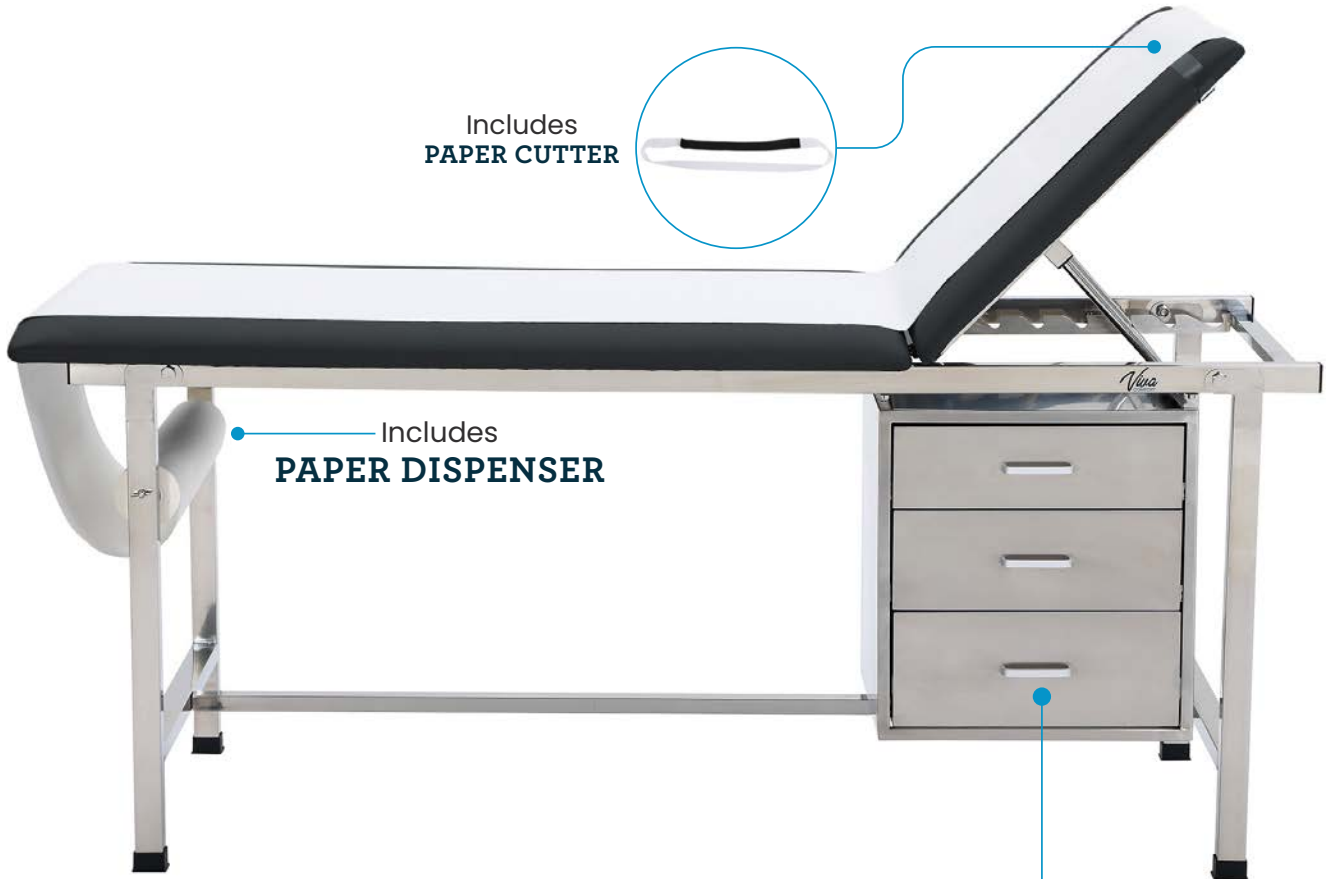

Includes  
**PAPER CUTTER**

Includes  
**PAPER DISPENSER**

**ADJUSTABLE BACKREST**

Can be positioned at different heights for the patient's optimal comfort

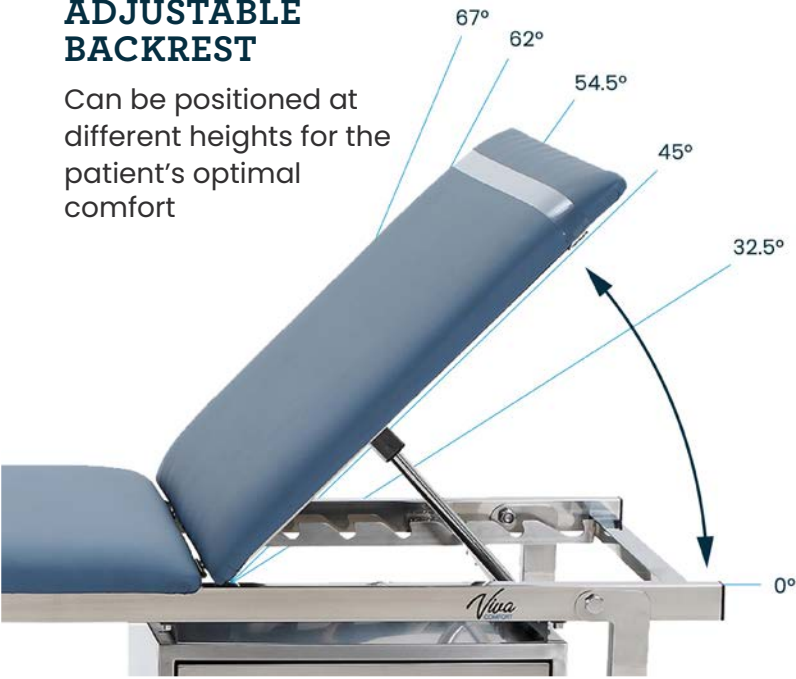

Also available with  
**3 DRAWER SET**

# ADI996-01-DR-3

## NOBLE-LINE ADJUSTABLE EXAM TABLE

### With Shelf and Exam Paper Roll Dispenser

- Foldable leg design helps provides space-saving storage
- Stainless-steel frame for longevity and easy cleaning
- Includes paper roll dispenser
- Overall Dimensions: 31.5" H X 27.5" W X 74.8" L
- Total Weight: 73.6 lb
- Adjustable backrest
- Rubber feet help prevent floor scratches
- Antimicrobial mattress provides a hygienic environment
- Backrest adjust to angles: 0°, 32.5°, 45°, 54.5°, 62°, and 67°

2-INCH PADDED  
FOAM PU LEATHER  
UPHOLSTERY

# ADI996-02-BLK

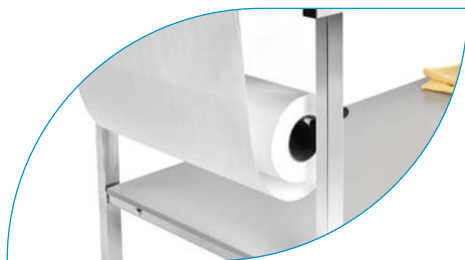

PAPER DISPENSER

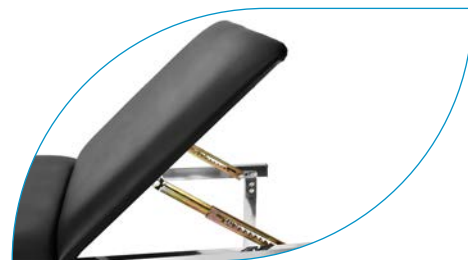

AJUSTABLE BACKREST



FOLDABLE LEGS



SHELF



# NOBLE-LINE MAHOGANY WOODEN EXAM TABLE

# ADI996-03-MA

## With Full Shelf

- Equipped shelf provides storage space for various medical equipment
- Wooden frame for longevity and aesthetic appeal
- Integrated paper roll dispenser
- Overall Dimensions: 31.5" H X 28.5" W X 75.5" L
- Total Weight: 112 lb
- Adjustable backrest
- 2-inch padded mattress delivers optimal comfort



### CONVENIENT

Paper roll dispenser will help reduce the risk of cross-contamination between patients

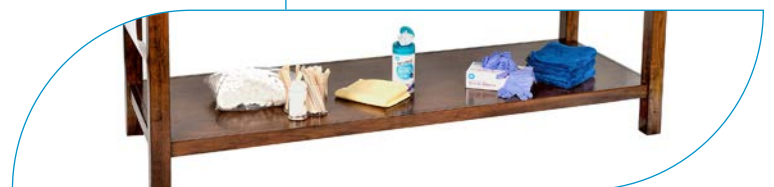

**BUILT-IN SHELF PROVIDES  
AMPLE STORAGE**

# NOBLE-LINE BLACK STRAIGHT LINE TREATMENT TABLE

- Wooden frame for longevity and aesthetic appeal
- Rounded corner top ensures patients' safety
- 2.25-inch padded mattress delivers optimal comfort
- Overall Dimensions: 31" H X 24" W X 72" L
- Total Weight: 77 lb

# ADI996-04-BLK

2.25-INCH PADDED  
FOAM UPHOLSTERY



## PROTECTION

Rounded corner top to ensure safety and long-term use

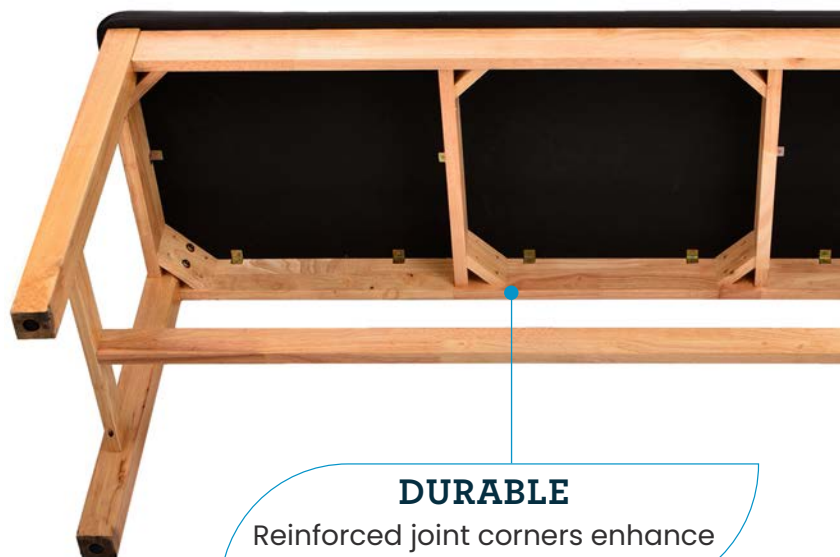

## DURABLE

Reinforced joint corners enhance stability and longevity

# REGAL-LINE

## REHAB TABLES



## REGAL-LINE UPHOLSTERED THERAPY REHAB MAT TABLE

- Generous size provides ample space
- Wooden frame for longevity and aesthetic appeal
- Overall Dimensions: 18.5" H X 53" W X 72.5" L
- Total Weight: 99 lb
- 2-inch padded mattress for optimal comfort
- Engineered with a sturdy 6-leg design and center supports

# ADI996-05-BLK

2-INCH PADDED  
FOAM UPHOLSTERY



**STURDY**

6-leg design and center supports provides long-lasting strength and durability.



BOTTOM STRUCTURE



# ELITE-LINE

## POWER TREATMENT TABLES



## ELITE-LINE OPEN BASE POWER EXAM TABLE

### 3-Section

- Overall Dimensions:  
18.89"-35.4" H X 26" W X 77" L
- Total Weight: 145.5 lb
- Motor Quantity: 1 motor, 6000N
- Motor Voltage: 110v

- Built-in face cutouts
- Hands-free height adjustment
- Adjustable feet for uneven surfaces
- Hi-lo function can be located from all four sides
- Foot release caster system makes it easy to move
- Antimicrobial upholstery can be easily sterilized
- Gas spring system for back and head adjustment
- Removable stirrups sold separately



# ADI903-01

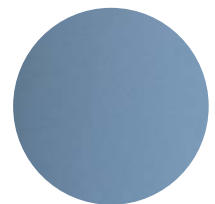

MIDNIGHT EXPRESS



*Stirrups Removable*  
# ADI903-01-STIRR



# ADI903-PAPER

PAPER ROLL ATTACHMENT



**Removable Face Cutout**  
Provides unobstructed breathing



**Foot Release Caster System**  
Makes the table mobile or stationary



**Hands-Free Height Adjustment**  
With the use of the foot bar

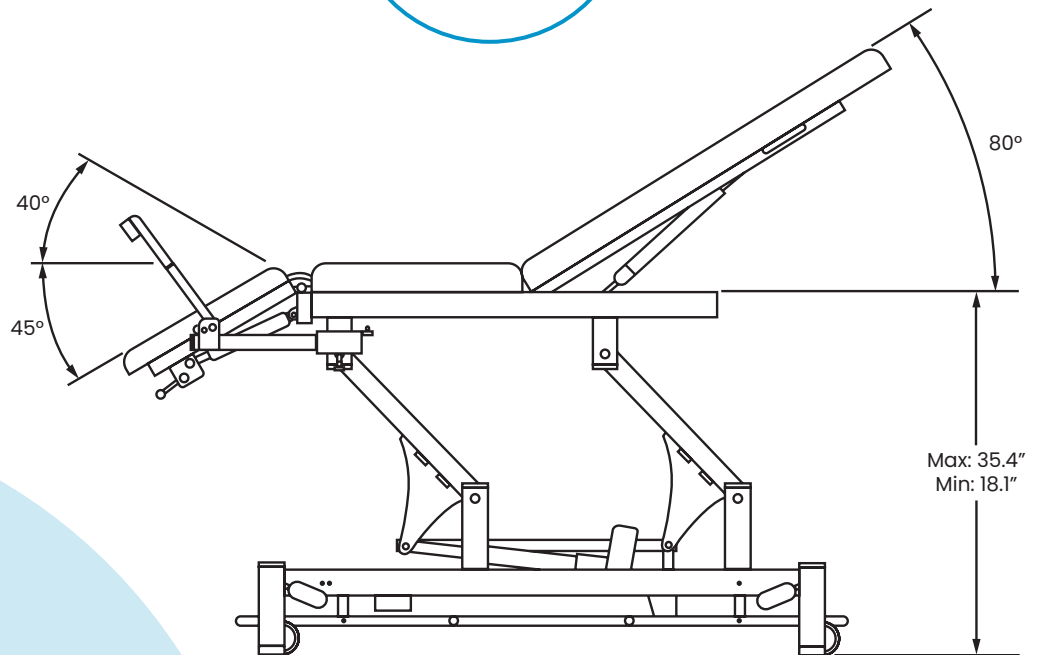

**STIRRUP**

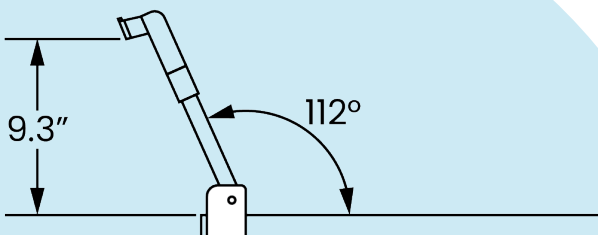

## ELITE-LINE HI-LO POWER MAT THERAPY TABLE

- Overall Dimensions: 18.89"– 36.61" H X 47" W X 75" L
- Total Weight: 210 lb
- Motor Quantity: 1 motor, 8000N
- Motor Voltage: 110v

- Extra-wide size
- Includes guard rails
- Built-in face cutouts
- Hands-free height adjustment
- Adjustable feet for uneven surfaces
- Hi-lo function can be located from all four sides
- Foot release caster system makes it easy to move
- Antimicrobial upholstery can be easily sterilized

# ADI903-02



### GUARD RAILS

Straightforward side rail design enables quick installation of the safety rails



ADA COMPLIANT



450 LB CAPACITY



MIDNIGHT EXPRESS

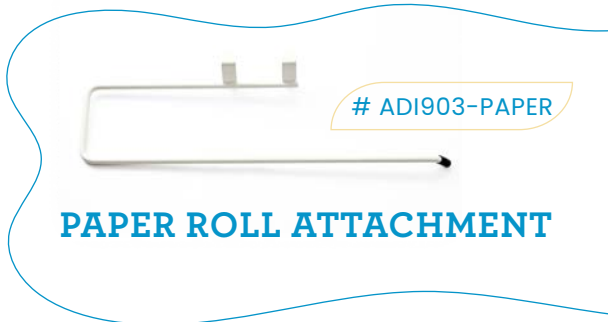

# ADI903-PAPER

PAPER ROLL ATTACHMENT





**Removable Face Cutout**

Provides unobstructed breathing



**Hands-Free Height Adjustment**

With the use of the foot bar



**Foot Release Caster System**

Makes the table mobile or stationary

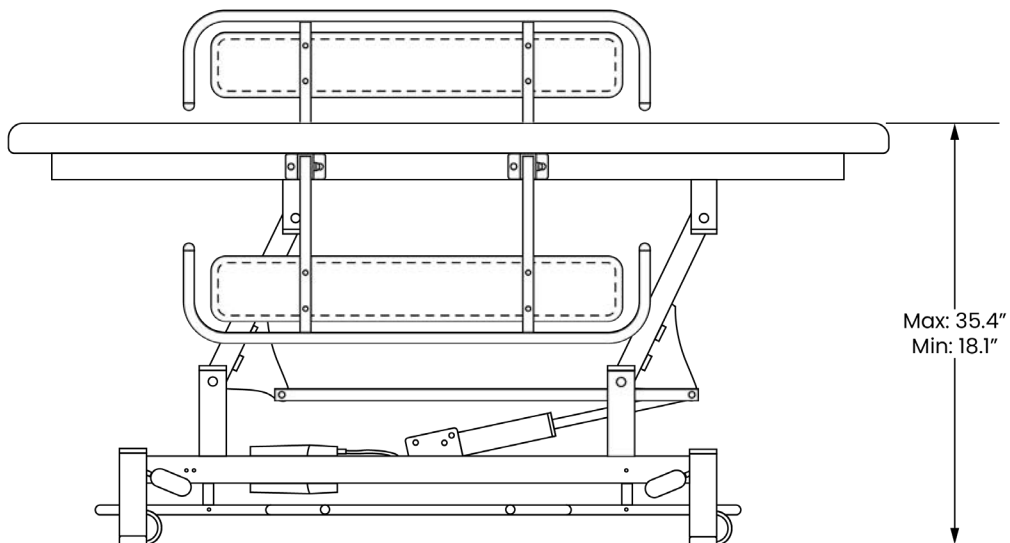

## ELITE-LINE HI-LO POWER TREATMENT TABLE

### With Padded Side Rails

- Overall Dimensions: 18.89" - 36.6" H X 26" W X 70" L
- Total Weight: 142 lb
- Motor Quantity: 1 motor, 6000N
- Motor Voltage: 110v

- Includes guard rails
- Built-in face cutouts
- Hands-free height adjustment
- Adjustable feet for uneven surfaces
- Hi-lo function can be located from all four sides
- Foot release caster system makes it easy to move
- Antimicrobial upholstery can be easily sterilized

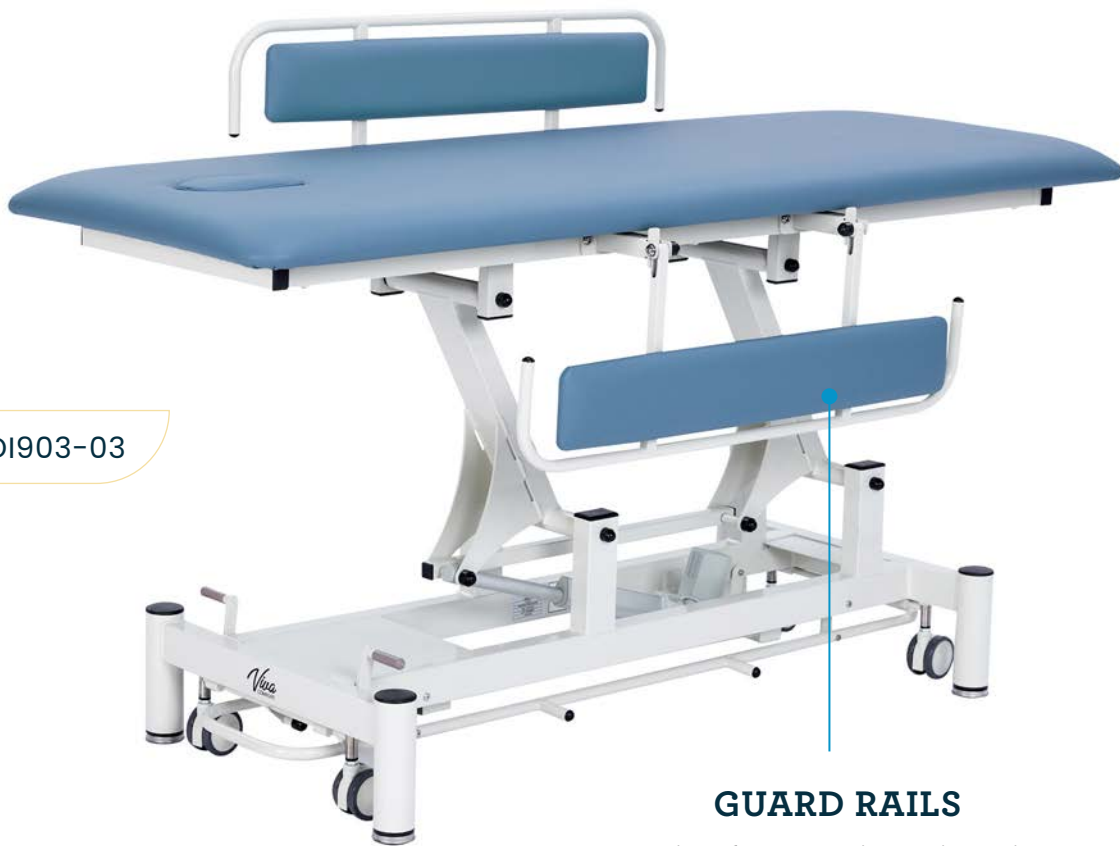

# ADI903-03



ADA COMPLIANT



550 LB CAPACITY

### GUARD RAILS

Straightforward side rail design enables quick installation of the safety rails



MIDNIGHT EXPRESS



# ADI903-PAPER

PAPER ROLL ATTACHMENT



**Removable Face Cutout**

Provides unobstructed breathing

**Foot Release Caster System**

Makes the table mobile or stationary

**Hands-Free Height Adjustment**

With the use of the foot bar

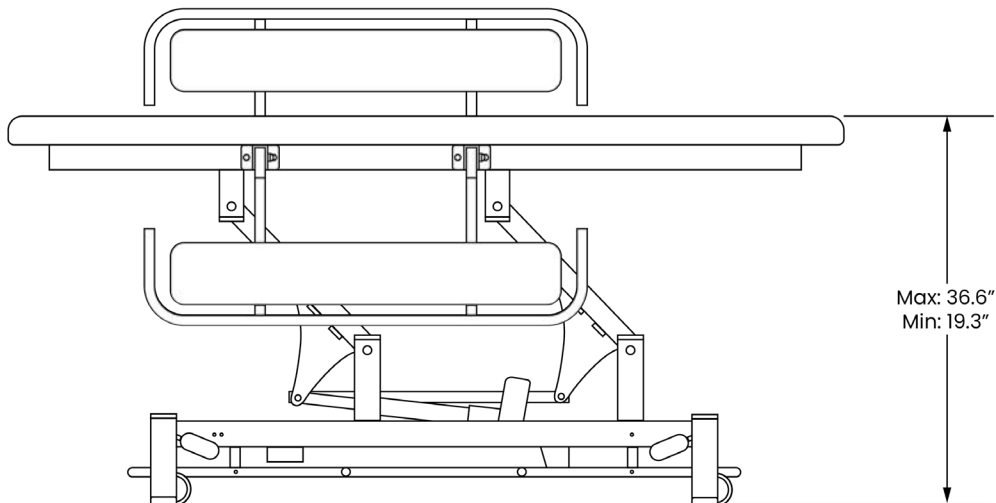

26

# IMAGING POWER TABLE

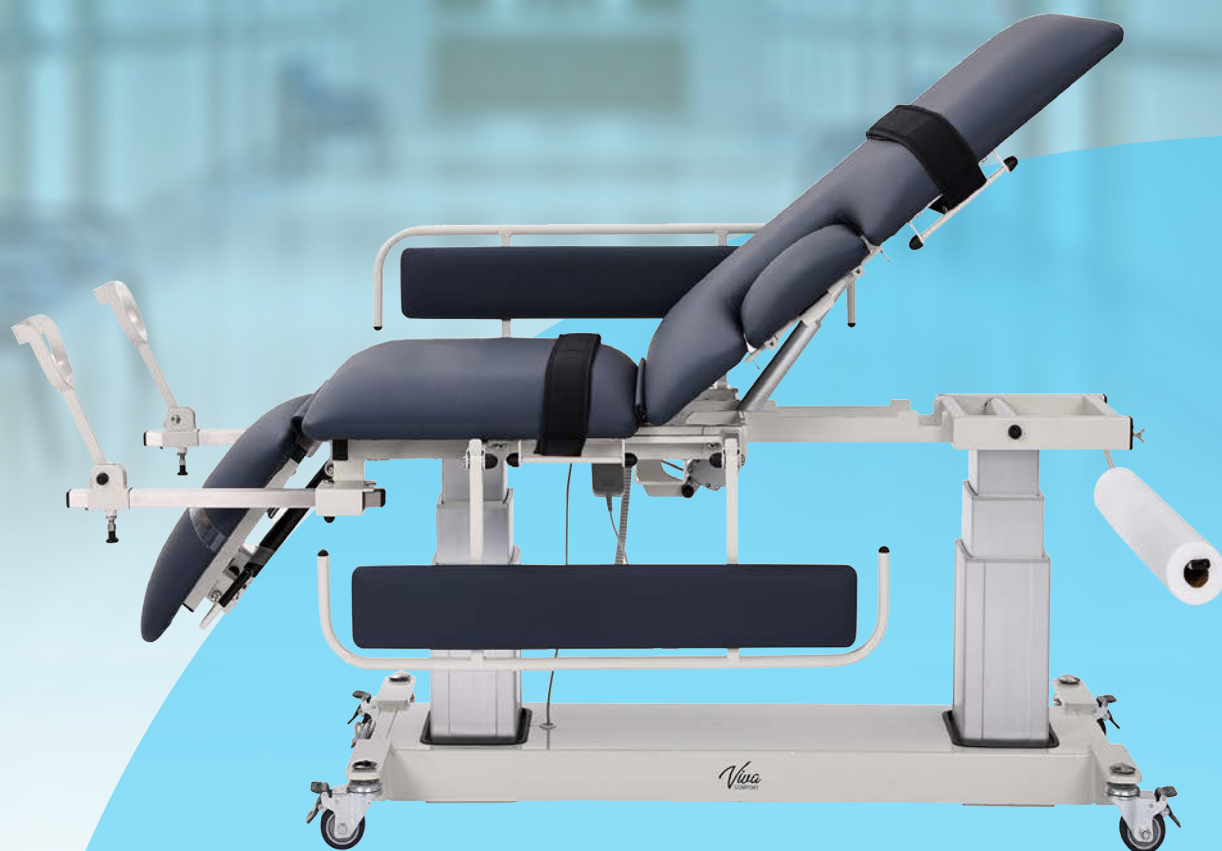

## ELITE-LINE MULTI-USE IMAGING POWER TABLE

With 3-Section Top & Drop Window

- Manual footrest
- Heavy-duty wheels
- Antimicrobial upholstery
- Pneumatic adjustable backrest
- Remarkable weight capacity of 550 lbs
- 10" x 10" drop window to enhance accessibility
- Easy-to-use hand control for height adjustments
- All-welded base and top frame, equipped with a dual-column lift system
- Additional accessories available



BLUE

# ADI903-04



1,100 LB STATIC  
WEIGHT  
CAPACITY

550 LB  
DYNAMIC  
WEIGHT  
CAPACITY

- Overall Dimensions: 21.45"-37.2" H X 27.5" W X 77" L
- Total Weight: 242 lb
- Motor Quantity: 2 Column Motor, 1 Single Line
- Column Motor: 4000N, and 1 Double Line
- Column Motor: 4000N
- Motor Voltage: 110v
- Watts: 400VA
- Motor Certification: CE, ETL
- Padding: 3" thick high-density foam



**10"x 10" Drop Window**  
Enhances accessibility

**Medical Grade  
3" Heavy-Duty Wheels**

Can handle the table's weight capacity

**Dual-Column Lift System**  
Enables quick and smooth height adjustments

**Cable Management System**  
Built-in power cord storage

- Offers Trendelenburg and Reverse Trendelenburg angles of +20° to -20°
- Leg section and backrest adjustments of up to 80°



*Trendelenburg*



*Reverse Trendelenburg*



*Supine*

**AVAILABLE ACCESSORIES:**



# ADI903-04-PA



# ADI903-04-RA



# ADI903-04-SS



# ADI903-04-STIR



*Trendelenburg*



*Reverse Trendelenburg*



*Supine*

# PHYSICAL THERAPY EQUIPMENT





# FOLDING PARALLEL BARS

**7 feet**

- Overall Dimensions: 28" - 41" H X 16" - 23.8" W X 83.9" L
- Total Weight: 123 lb
- Qty of Height Adjustment Holes: 14
- Height Increments: 0.59"

- Includes guard rails
- Foldable, space-saving design
- Square telescoping steel uprights
- 1-1/2" one-piece stainless-steel handrails
- End bumpers on the ends of each handrail
- Double stiffening rails ensure unmatched stability
- Built-in height knob eliminates unwanted movement
- Width can be easily adjusted to suit user preferences

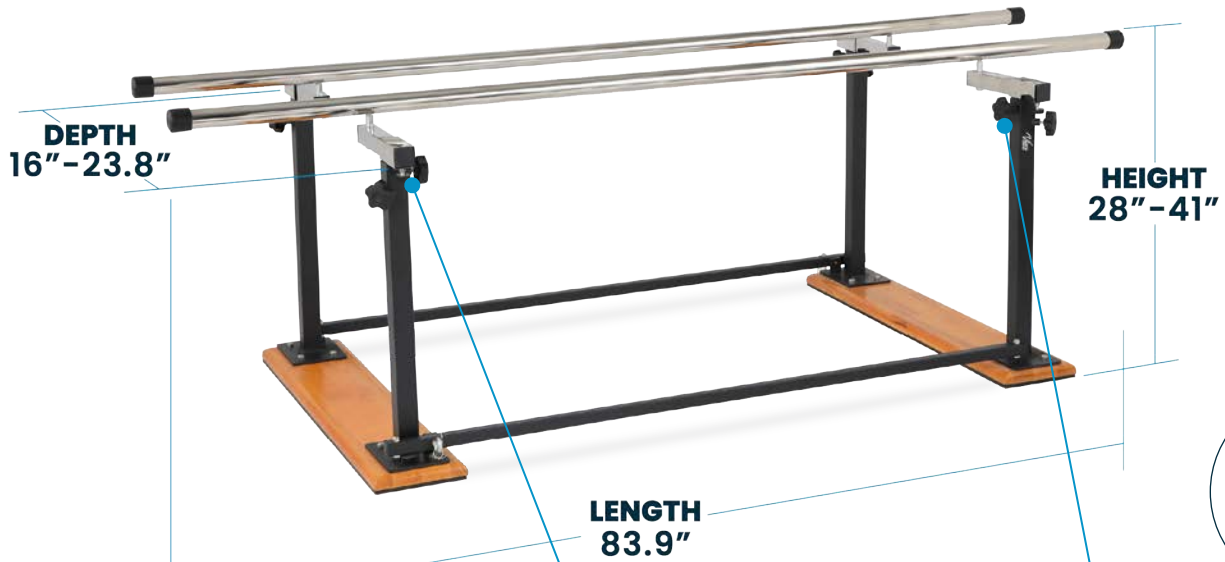

# ADIME905-01

**SPACE-SAVING**  
Easily fold and store them when not in use



## SMALL UP & DOWN STAIRCASE

- Includes guard rails
- Hardwood plywood base
- Overall Dimensions: 47.6" H X 54.7" W X 33" D
- Total Weight: 100 lb
- Platform Dimensions: 11.81" H x 29.92" W x 23.23" D
- 1 Step Dimensions: 5.91" H x 29.92" W x 9.84" D
- 2 Step 1st Step Dimensions: 3.94" H x 29.92" W x 9.84" D
- 2 Step 2nd Step Dimensions: 5.91" H x 29.92" W x 9.84" D

- Two different step height options
- Powder-coated steel uprights and brace-reinforced underside
- Crafted with steel fasteners and metal braces
- Four full-width pieces of safety tread on the platform
- Two full-width pieces of safety tread on each step
- One-piece handrail support system ensures a secure grip

# ADIME906-01



### NON-SLIP

Full-width tread provides ultimate safety for patients

# THERAPY SHOULDER CONDITIONING FINGER LADDER

**2 Pack**

- Overall Dimensions: 54" H X 2" W X 1" D
- Total Weight: 2.2 lb

- Lightweight material
- Made from premium, mold-resistant pine wood
- Designed to help patients regain mobility and strength due to injury

# ADI910-01-2



## REHABILITATION

Excellent therapeutic instrument for  
shoulders, wrists, and elbows

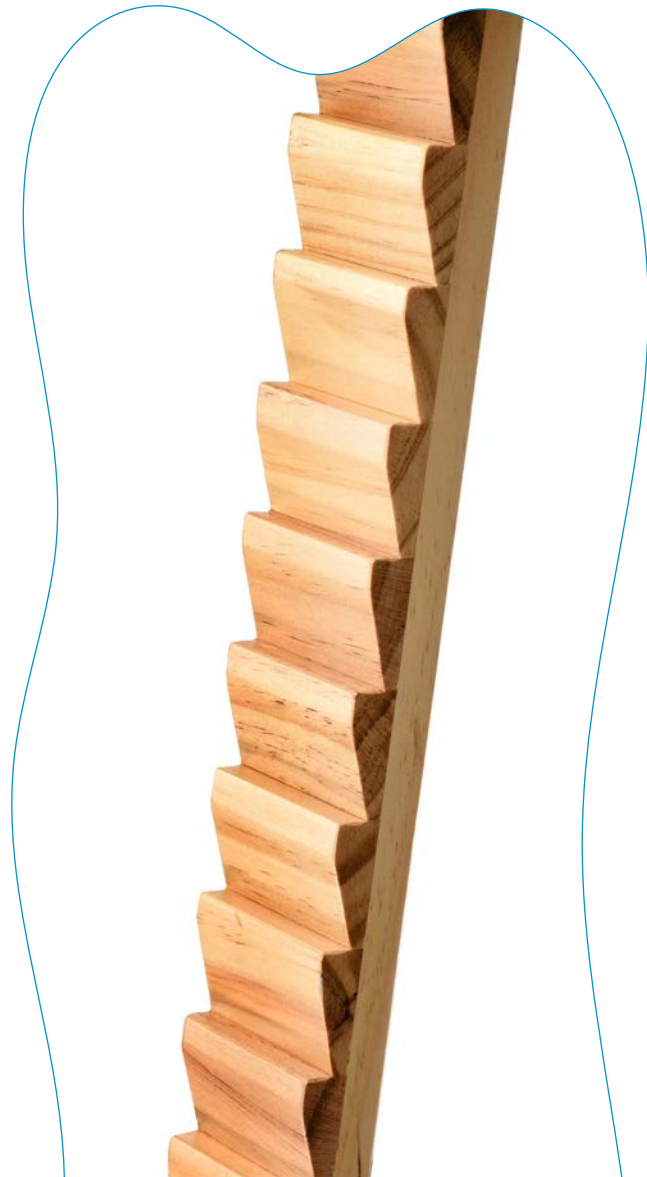

# CARTS



## UNIVERSAL MOBILE CART

### Without Mounting Plates

- Seamlessly integrates with various monitoring systems
- Integrated cord organizer keeps cables tidy
- Overall Dimensions: 31.4"H x 22.5" D
- Total Weight: 22.04 lb

### ADJUSTABLE

Telescoping pole offers a height range of 31.49" to 51.18"

# ADIME912-C

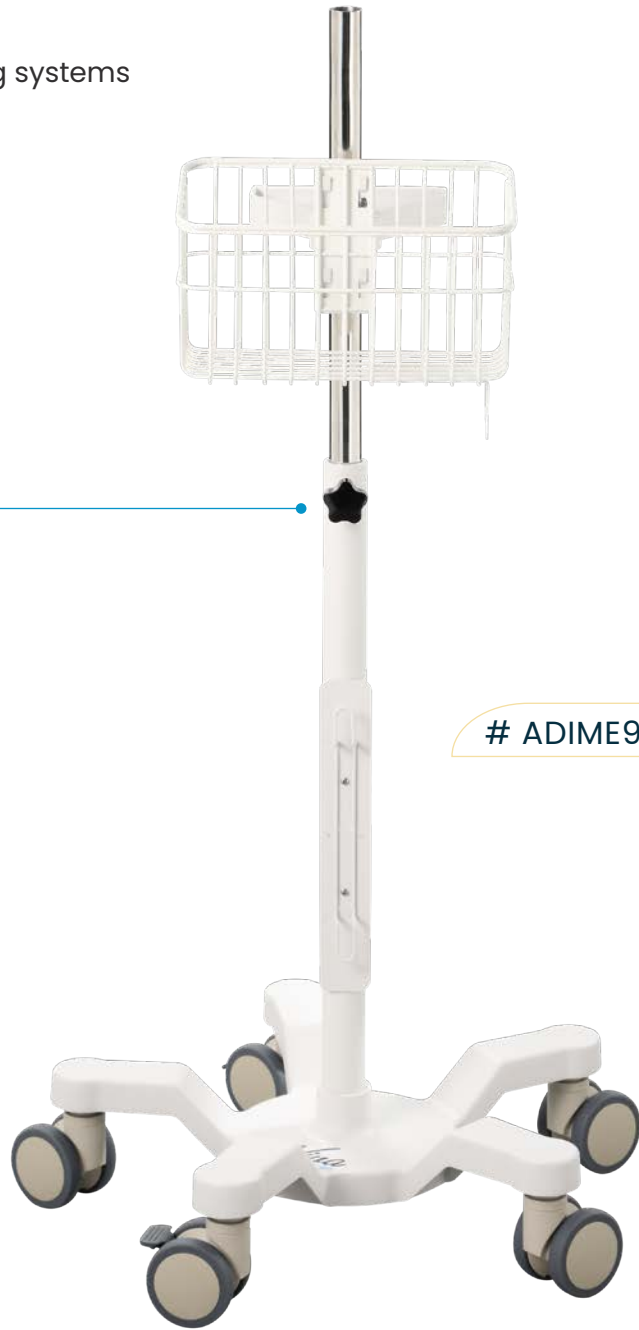

### INCLUDED

Wire basket provides storage space



## 36 Carts



**For Welch Allyn  
Connex Spot Monitor**

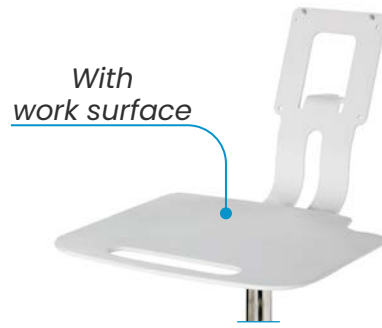

**For Welch Allyn  
Connex Spot Monitor**



**For Edan Monitor**



**For RVS-100  
Vital Signs Monitor**



**For Covidien  
PM10N Series Monitor**

KIT #	DESCRIPTION	WEIGHT	DIMENSIONS
ADIME912-C-MP-01	Universal Mobile Cart + Welch Allyn Connex Mounting Plate	27.11 lb	8.27" L x 11.22" W x 11.61" D
ADIME912-C-MP-02	Universal Mobile Cart + Welch Allyn Connex Mounting Plate With Work Surface	27.11 lb	8.27" L x 11.22" W x 11.61" D
ADIME912-C-MP-03	Universal Mobile Cart + Edan Monitor Mounting Plate	26.01 lb	9.84" L x 4.78" W x 9.84" D
ADIME912-C-MP-04	Universal Mobile Cart + RVS-100 Vital Signs Monitor Mounting Plate	26.01 lb	9.84" L x 4.78" W x 9.84" D
ADIME912-C-MP-05	Universal Mobile Cart + Covidien PM10N Series Mounting Plate	26.01 lb	9.45" L x 4.17" W x 9.45" D



## MOBILE STAND

for Welch Allyn 4400  
Vital Signs Monitor

- Easy to clean surface ensures optimal sanitation
- Lifting function to adjust pole height for maximum comfort and accessibility
- Overall Dimensions: 41.73" x 20.47" x 20.47"
- Total Weight: 26.46 lb

# ADIME911-01



### BASKET

Dimensions: 11.02" x 6.29" x 5.70"



38

# EXAM ROOM CABINETS





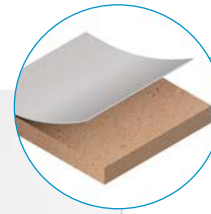

**Antimicrobial Laminate**  
**MDF**



**MATERIAL:**

- Constructed from long-lasting MDF material
- Chip-resistant edges that can handle bumps and bangs
- Exclusive antimicrobial high-pressure laminate exterior

**FINISH:**

Versatile grey finish will seamlessly blend into your medical facility

**HARDWARE:**

Deluxe soft-closing drawer rails and door hinges are equipped on our wall and base cabinets



## 36-INCH BASE CABINET

With Left Sink, Right Sink, or No Sink

- Easy-to-clean surfaces
- Modern aluminum handles
- Each cabinet has 3 drawers and 1 door
- Backsplash of 3.125" to protect your walls
- Overall Dimensions: 35.5" H X 36" W X 19" D

- Exclusive antimicrobial high-pressure laminate
- Soft-close hinges and adjustable interior shelves
- Chip-resistant edges can handle bumps and bangs without degrading
- Medical sink that is ideal for regularly disinfecting your hands

### Stainless Steel Medical Sink

7.87" x 16.9" x 16.9"

Faucet Style: Gooseneck



### Cabinet With Left Sink

#ADIME902-BASE-36-LS-GRY

### Cabinet With Right Sink

#ADIME902-BASE-36-RS-GRY

### Cabinet With No Sink

#ADIME902-BASE-36-NS-GRY



Soft-Close Hinges

## 48-INCH BASE CABINET

### With Left Sink, Right Sink, or No Sink

- Easy-to-clean surfaces
- Modern aluminum handles
- Each cabinet has 2 drawers and 4 doors
- Backsplash of 3.125" to protect your walls
- Antimicrobial high-pressure laminate
- Soft-close hinges and adjustable shelves
- Chip-resistant edges can handle bumps and bangs without degrading
- Medical sink that is ideal for regularly disinfecting your hands.
- Overall Dimensions: 35.5" H x 48" W x 19" D



### Cabinet With Left Sink # ADIME902-BASE-48-LS-GRY

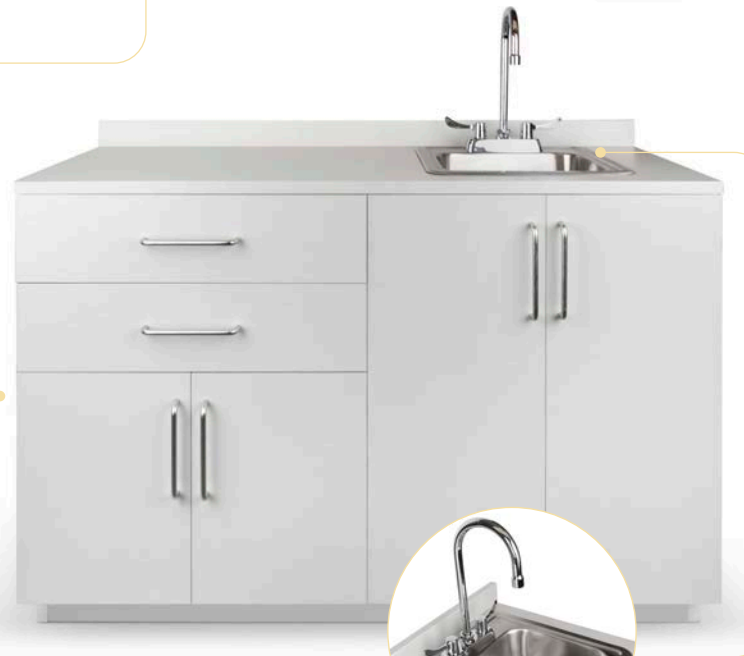

### Cabinet With Right Sink # ADIME902-BASE-48-RS-GRY



**Stainless Steel Medical Sink**  
7.87" x 16.9" x 16.9"  
**Faucet Style:** Gooseneck



### Cabinet With No Sink # ADIME902-BASE-48-NS-GRY



**Soft-Close Hinges**

## WALL CABINET

36" or 48" Wide

**36-Inch**

# ADIME902-WALL-36-GRY



- Easy-to-clean surfaces
- Modern aluminum handles
- Exclusive antimicrobial high-pressure laminate
- Chip-resistant edges can handle bumps and bangs without degrading
- Each cabinet has 2 soft-close hinged doors and 2 adjustable shelves
- 36" Overall Dimensions: 24" H X 36" W X 12" D
- 48" Overall Dimensions: 24" H X 48" W X 12" D



**Soft-Close Hinges**



**4 Internal Shelves**



**48-Inch**

# ADIME902-WALL-48-GRY

## NON-ALARMED STEEL CABINET

### For Defibrillators

- Overall Dimensions: 15" H X 15" W X 7" D
- Total Weight: 10 lb

- Easy-to-clean , long-lasting steel surface
- Large window allows for quick identification
- Single handle, pull door allows for instant access
- Designed to accept most commonly used AED devices
- "Emergency Defibrillator" in bold, red lettering makes it easy to spot during an emergency



### **Bold, Red Lettering**

Easy to spot during an emergency

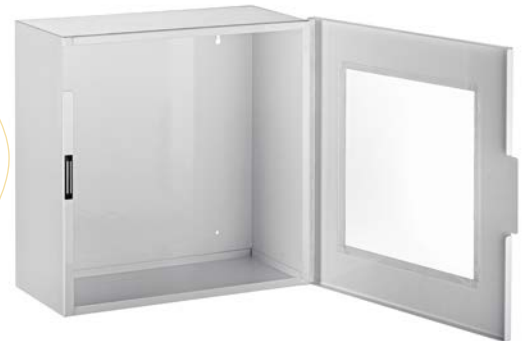

# ADI999-01



# LARGE MEDICAL SECURITY CABINET

## Dual Locks

- Overall Dimensions: 21" H X 16" W X 6" D
- Total Weight: 10 lb

- Welded steel construction provides corrosion & scratch resistance
- Prioritizes safety with dual locks and separate keys
- Ample storage space for prescriptions and first aid supplies
- Equipped with three large shelves and two mini shelves
- Adorned medical white cross symbol helps to identify the purpose and contents of the cabinet visually



### STORAGE

Three full-length shelves for various medical equipment

### SUPPLEMENTAL

Two mini shelves for smaller bottles



# ADI999-04-BLU

BLUE



# ADI999-04-WHI

WHITE



# ADI999-04-RED

RED



# ADI999-04-PUR

PURPLE

# LARGE MEDICAL SECURITY CABINET

## Dual Locks

- Overall Dimensions: 21" H X 16" W X 6" D
- Total Weight: 10 lb

# ADI999-06-WHI

WHITE



# ADI999-06-RED

RED



- Outfitted with a handle and four full-length shelves
- Prioritizes safety with dual locks and separate keys
- Welded steel construction provides corrosion & scratch resistance
- Ample storage space
- Door is outfitted with interior pocket for holding medical records and documents
- Convenient pull-out shelf you can pull out when you need additional working space
- Adorned medical white cross symbol helps to identify the purpose and contents of the cabinet visually

## STORAGE

Three full length shelves for various medical equipment



## OUTFITTED

Pull-out shelf for additional space and built-in interior pocket for documents

## LOCKING DRUG CABINET

- Overall Dimensions: 5.9" H X 12.5" W X 6" D
- Total Weight: 2.6 lb

# ADI999-05-WHI

- Prioritizes safety with a lock and key
- Compact design requires minimal space
- Welded steel construction provides corrosion & scratch resistance
- Ample storage space for prescriptions, OTC's and first aid supplies
- Adorned medical white cross symbol helps to identify the purpose and contents of the cabinet visually

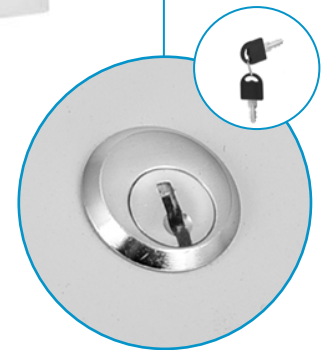
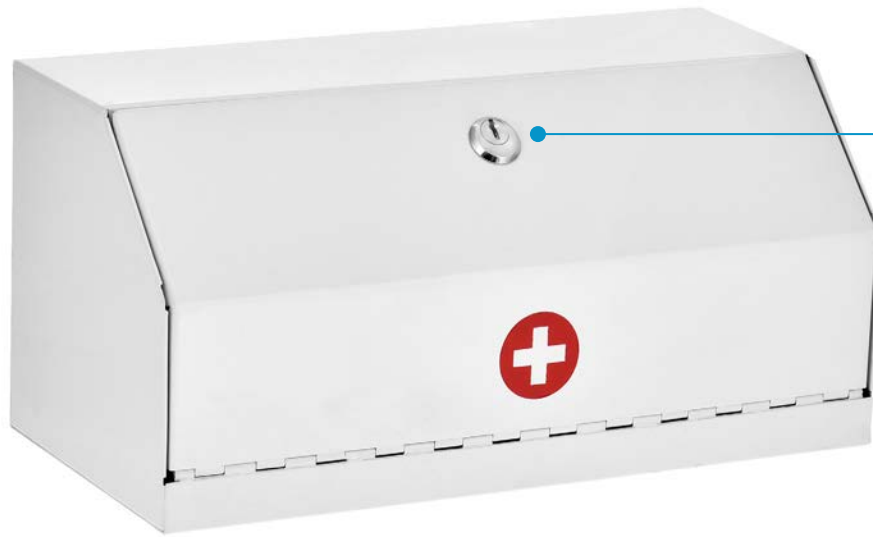

*Equipped*  
Lock and included key help  
safeguard the contents of  
the cabinet



### VERSATILE

Lid can open forward or upward





## MOUNTABLE CORNER, LOCKING MEDICAL CABINET

### Two Shelves

- Overall Dimensions: 14.01" H x 7.48" W x 7.48" D
- Total Weight: 9.04 lb
- Two shelves to store various medical supplies
- Corner-mountable, compact design
- Two keys to ensure you always have one on hand
- Great for hospitals, clinics, camps, schools, nursing homes, and even residential homes
- Door is adorned with a lock to prevent tampering

# ADIME999-01-1

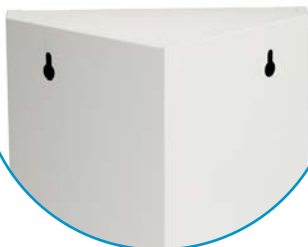

*Mounting Holes*



## SPECIMEN PASS-THRU CABINET

- Overall Dimensions: 12.7" H x 13.2" W x 6" D
- Total Weight: 9.5 lb
- Weight Capacity: 44.09 lb
- Both doors can not open simultaneously, providing optimal privacy
- Crafted from top-tier stainless steel
- Ample room for specimens of various sizes
- Easy-to-clean stainless steel surface
- Included stainless steel tray
- International symbol of a conical flask to help identify the specimen cabinet



# ADIME960-01



### CONFIDENTIALITY

Affixed springs avoids opening both doors simultaneously

# MEDICAL SCALES

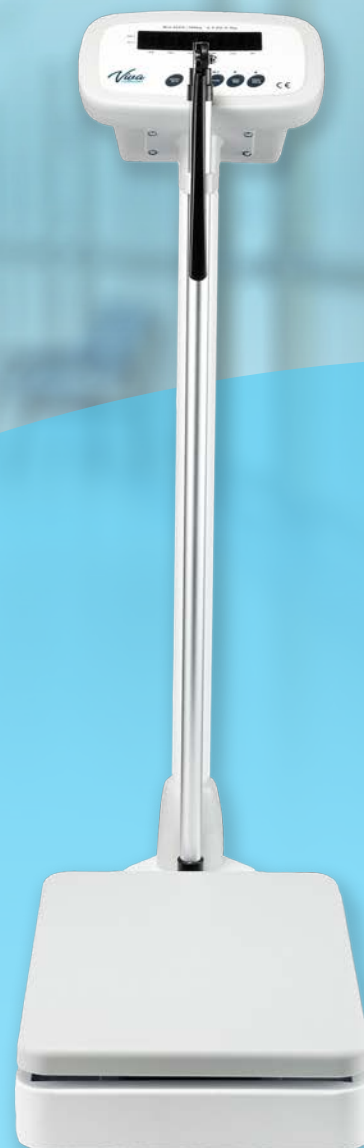

## DIGITAL PHYSICIAN SCALE

### With Height Rod

- Bright LCD screen
- Easy switch between lbs and kgs
- Hardy metal body to ensure durability
- Equipped with lightweight height rod
- Platform adorned with an anti-slip safety mat
- AC adapter or internal 6V rechargeable batteries
- Easily calculates patient's BMI
- Overall Dimensions: 37" H X 12" W X 20" D
- Height Rod Range: 31.5" to 82.6"
- Overall Weight: 20 lb

# ADIME904-01

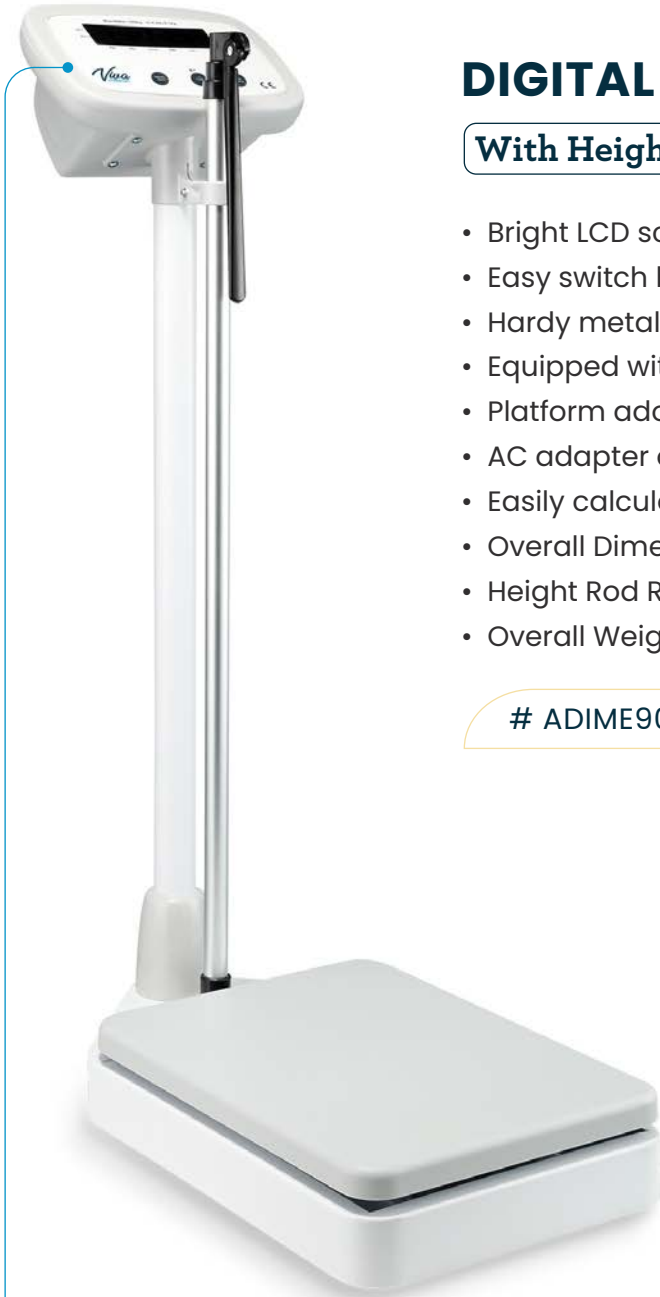

Bright LCD screen digitally shows your patients' weight in lbs. or kgs.





Digital display shows weight (lbs and kg) and BMI



Lightweight height rod is effortless to maneuver



Hardy metal body ensures its longevity



Functions with AC adapter or internal 6V rechargeable batteries

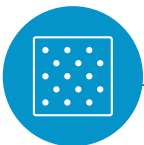

Platform adorned with an anti-slip safety mat



## PHYSICIAN BEAM SCALE

### With Height Rod

- Hardy metal body to ensure durability
- Equipped with lightweight height rod
- Platform adorned with an anti-slip safety mat
- Dual beams with two easy manual sliding weights
- Two easy gliding wheels to facilitate maneuvers
- Overall Dimensions: 58" H X 14" W X 19" D
- Height Rod Range: 23.6" to 83.8"
- Overall Weight: 35 lb

# ADIME904-02

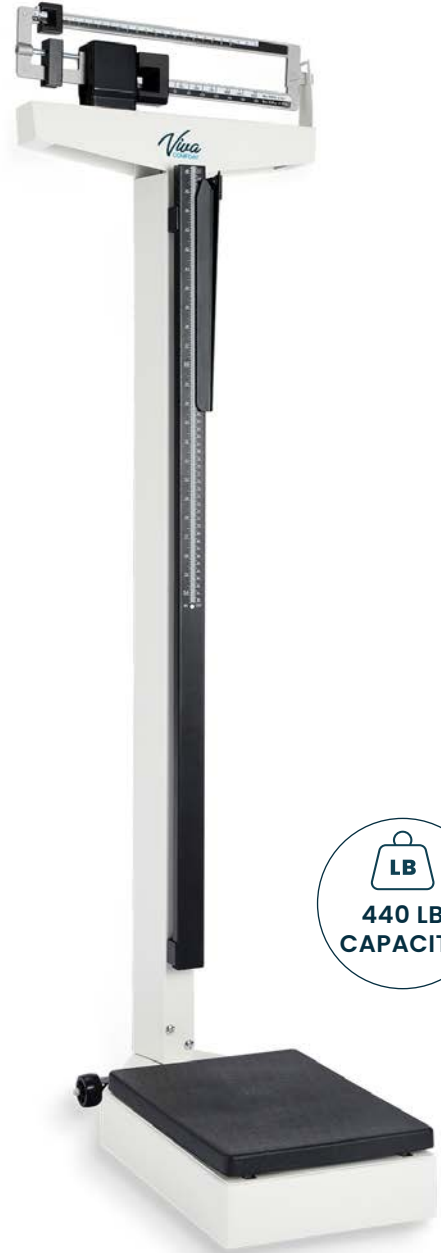



Dual beams with two easy manual sliding weights



Lightweight height rod is effortless to maneuver



Hardy metal body ensures its longevity

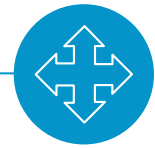

Two easy gliding wheels to maneuver the scale wherever needed

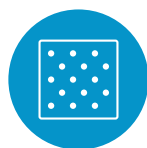

Platform adorned with an anti-slip safety mat

## MEDICAL WHEELCHAIR SCALE

- Bright LCD screen
- Easy switch between lbs and kgs
- Hardy metal body to ensure durability
- Handle and wheels make it easy to maneuver
- Adorned with non-slip adjustable leveling feet
- Built-in ramp on both sides allows for easy access
- Overall Dimensions: 32.5" H X 40" W X 48" L
- Overall Weight: 143 lb

# ADIME904-03







**Accessible**

With the included handle and wheels, you can maneuver the scale wherever needed



**Durable**

Hardy metal body ensures its longevity from continual wear and tear



**Stable**

Non-slip adjustable leveling feet guarantee a stable platform



**Accommodating**

Built-in ramp on both sides allows straightforward access to the scale

**DISPLAY**

Bright LCD screen digitally shows your patients' weight in lbs. or kgs.



## STAINLESS STEEL VETERINARY SCALE

- Convenient tare function
- Digital display for fast weight readings
- High-quality stainless steel construction
- Integrated wheels allow for seamless mobility
- Spacious and flat platform design for easy weighing
- Shows weight for up to 10 seconds after removing the animal
- Equipped with accurate load cells and advanced weighing technology
- Suitable for various animals, from pets like cats, dogs, rabbits, and smaller livestock
- Overall Dimensions: 2" H X 20" W X 44" L
- Overall Weight: 44 lb



# ADIME904-04



### DISPLAY

Bright LCD screen digitally shows your patients' weight in lbs. or kgs.





**Precision**

Accurate load cells, advanced weighing technology and easy-to-read digital display



**Convenient**

Tare function allows the deduction of bedding or container weight



**Power Saver**

Enabled with an auto sleep or power down function to save on battery life



**Optional**

Interface can be mounted with the bracket, or it can be left unattached



**Robust**

High-quality stainless steel construction ensures resilience and longevity



**Effortless**

Spacious platform for easy loading of animals without strain or injury



**Transportable**

Lightweight and outfitted with a handle, making it simple to move

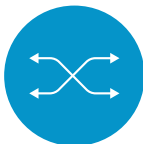

**Accommodating**

Suitable for various animals, from pets like cats, dogs, and rabbits to smaller livestock.



## MEDICAL HANDRAIL SCALE

- Dimensions: 51.6" H x 20.47" W x 24.4" D
- Overall Weight: 55.11 lb
- Weight Capacity: 660 lb (300 kg)

- Sturdy stainless steel structure
- Strategically positioned grips for comfort and security
- Low-level platform, only 2.4" from the ground
- Display contains essential operating keys
- Adjustable feet for uneven surfaces
- Two 1.5" wheels for manageable maneuverability
- Accuracy of 0.1 kg/0.2 lb

# ADIME904-05



### DISPLAY



Bright LCD screen digitally shows your patients' weight in lbs. or kgs.



**Ergonomic Handles**  
For utmost comfort



**Adjustable Feet**  
To keep it stable on uneven surfaces



# EXAM STOOLS



# PNEUMATIC HEIGHT ADJUSTABLE LUXE EXAM STOOL

- Seat height can be quickly altered
- Thick upholstery padding gives added comfort
- 5-star leg design provides stability when moving
- Smooth rolling wheels can handle carpeting and hard floors
- Overall Dimensions: 19" - 24.6" H X 23" W X 16" D
- Overall Weight: 12 lb

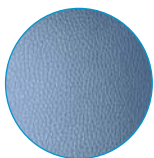

*MIDNIGHT EXPRESS*  
ADI910-01-BLU

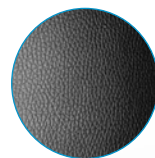

*BLACK*  
ADI910-01-BLK

## PNEUMATIC HEIGHT ADJUSTABLE EXAM STOOL

With Backrest

- Seat height can be quickly altered
- Ergonomically designed backrest
- Thick upholstery padding gives added comfort
- 5-star leg design provides stability when moving
- Smooth rolling wheels can handle carpeting and hard floors
- Overall Dimensions: 28"– 32.6" H x 22" W x 16.1 D
- Overall Weight: 16.5 lb

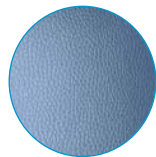

MIDNIGHT EXPRESS

ADI910-03-BLU

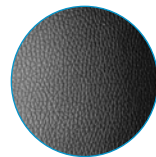

BLACK

ADI910-03-BLK



62

# BLOOD DRAWING CHAIRS





## PADDED BLOOD DRAWING CHAIR

- Overall Dimensions: 36" H X 30.5" W X 28" D
- Overall Weight: 35 lb
- Weight Capacity: 400 lb

- Padded for optimal patient comfort
- Armrest that can lock into the correct position
- Easy-to-clean antimicrobial polyurethane leather
- Welded powder-coated frame with reinforced stress points



**ARMREST HEIGHT ADJUSTMENT:**  
24.4" - 34.2"

**BLACK**  
# ADI997-01-BLK

**MIDNIGHT EXP.**  
# ADI997-01-BLU

**500 LB CAPACITY**

### Optional Accessory

#### DRAWER

for Padded Blood Drawing Chair

**BLACK** # ADI997-01-D-BLK    **MID. EXP.** # ADI997-01-D-BLU



## PADDED BLOOD DRAWING CHAIR

**With Drawer**

- Amply sized 4" x 6" drawer for various medical supplies

**BLACK**  
# ADI997-01D-BLK

**MIDNIGHT EXPRESS**  
# ADI997-01D-BLU

## BARIATRIC PADDED BLOOD DRAWING CHAIR

- Overall Dimensions: 40" H X 35" W X 30" D
- Overall Weight: 48.5 lb

- Securely holds up to 500 lb
- Padded for optimal patient comfort
- Armrests that can lock into the correct position
- Easy-to-clean antimicrobial polyurethane leather
- Welded powder-coated frame with reinforced stress points



**ARMREST HEIGHT ADJUSTMENT:**  
27.8" - 38.5"

- BLACK**  
# ADI997-01-BLK-HD
- MIDNIGHT EXP.**  
# ADI997-01-BLU-HD

**500 LB CAPACITY**

### Optional Accessory

#### DRAWER

for Bariatric Padded Blood Drawing Chair

- BLACK**  
# ADI997-01-D-BLK
- MID. EXP.**  
# ADI997-01-D-BLU



## BARIATRIC PADDED BLOOD DRAWING CHAIR

**With Drawer**

- Amply sized 4" x 6" drawer for various medical supplies

- BLACK**  
# ADI997-01D-BLK-HD
- MIDNIGHT EXPRESS**  
# ADI997-01D-BLU-HD

# LUXE UPHOLSTERED BLOOD DRAWING CHAIR

- Padded for optimal patient comfort
- Armrest that can lock into the correct position
- Easy-to-clean antimicrobial polyurethane leather
- Welded powder-coated frame with reinforced stress points
- Overall Dimensions: 35" H X 28" W X 25" D
- Overall Weight: 54 lb

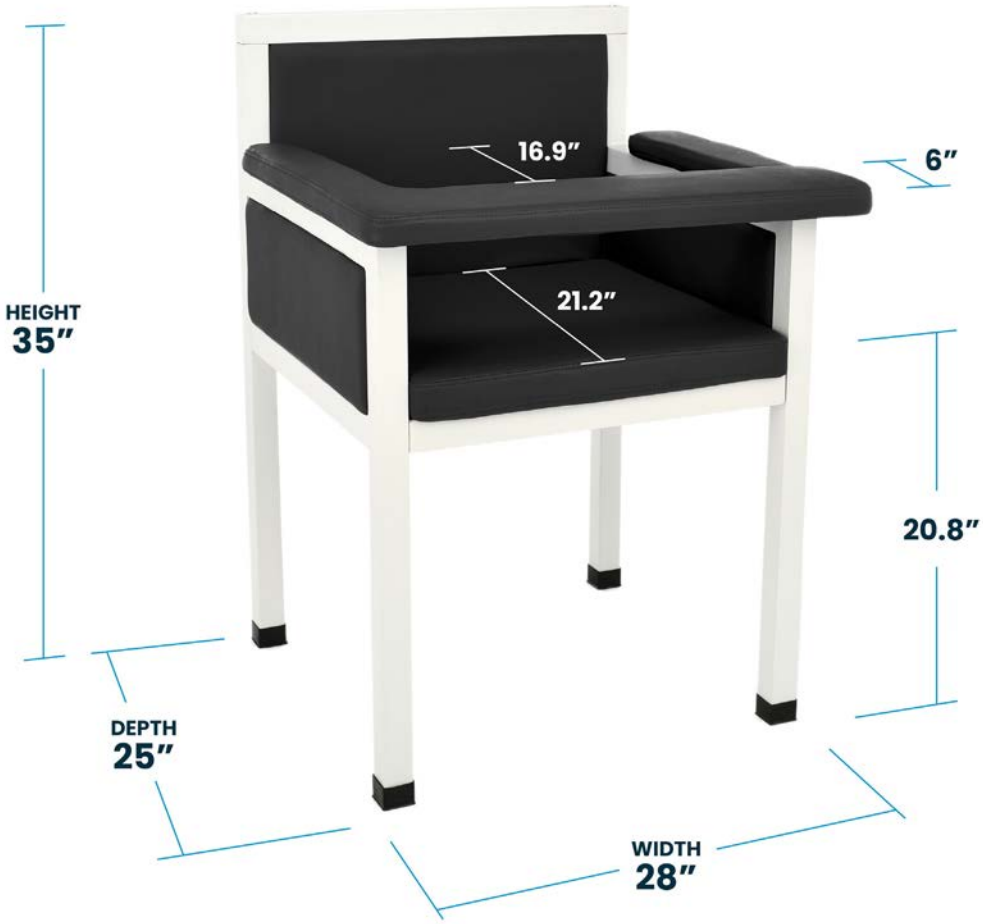

**BLACK**

# ADI997-02-BLK



**MIDNIGHT EXPRESS**

# ADI997-02-BLU



## FOLDING PADDED BLOOD DRAWING CHAIR

# ADI997-03-BLK

- Can be effortlessly transported
- Foldable design to facilitate storage
- Easy-to-clean antimicrobial upholstery
- Seat designed with a thick cushion for patient comfort
- Equipped with nylon glides on the legs to avoid scratching your floors
- Overall Dimensions: 37" H X 25.5" W X 24" D
- Overall Weight: 28 lb



EASILY FOLDABLE



# HEIGHT MEASURING RODS

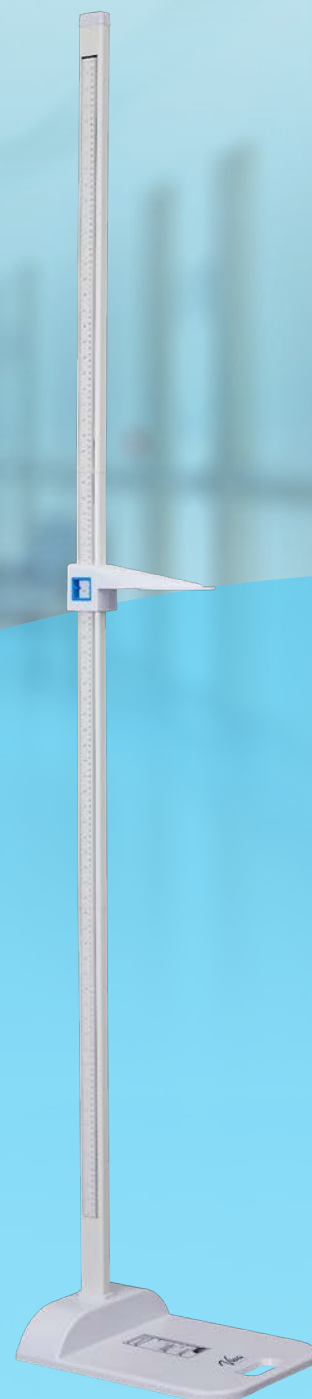

# ADIME907-01

## ALUMINUM PORTABLE HEIGHT MEASURING ROD

For Adults and Children,  
and with Carrying Bag

- Sliding baffle for precise measurement
- Easy to transport, assemble and disassemble
- Dimensions: 82.68" x 12.6" x 16.54"
- Weight: 5.73 lb



INCLUDED CARRYING BAG

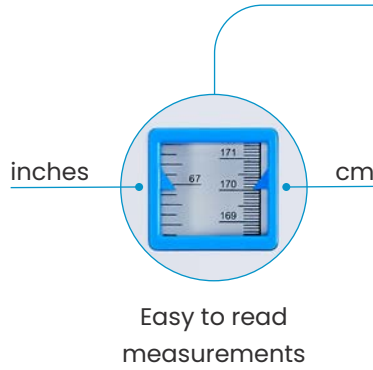

# ADIME907-02

## ALUMINUM WALL MOUNTED HEIGHT MEASURING ROD

For Adults and Children

- Offered in two wall mounting options
- Measuring range spans from 23.62" to 78.74"
- Dimensions: 36.81" H x 1.33" W x 2.08" D
- Weight: 1.65 lb



# GLOVE DISPENSERS



## ACRYLIC GLOVE DISPENSER

Single Box Capacity

- Crafted from high-quality acrylic
- Can be mounted vertically and horizontally
- Elevates your space with its modern appearance
- Universal design accommodates all glove brands
- Able to be mounted with supplied adhesive strips or screws
- Overall Dimensions: 5.3" H X 10.2" W X 3.5" D
- Overall Weight: 0.7 lb



Mounting Hardware Included



CLEAR

ADI902-01



BLACK

ADI902-01-BLK



# ACRYLIC GLOVE DISPENSER

Double Box Capacity

- Crafted from high-quality acrylic
- Can be mounted vertically and horizontally
- Elevates your space with its modern appearance
- Universal design accommodates all glove brands
- Able to be mounted with supplied adhesive strips or screws
- Overall Dimensions: 10.8" H X 10.2" W X 3.5" D
- Overall Weight: 1.3 lb



Mounting Hardware Included



**CLEAR**  
ADI902-02

**BLACK**  
ADI902-02-BLK



# ACRYLIC GLOVE DISPENSER

Triple Box Capacity

- Crafted from high-quality acrylic
- Can be mounted vertically and horizontally
- Elevates your space with its modern appearance
- Universal design accommodates all glove brands
- Able to be mounted with supplied adhesive strips or screws
- Overall Dimensions: 16" H X 10.2" W X 3.5" D
- Overall Weight: 1.8 lb



Mounting Hardware Included



**CLEAR**

ADI902-03

**BLACK**

ADI902-03-BLK



# ACRYLIC GLOVE DISPENSER

Quad Box Capacity

- Crafted from high-quality acrylic
- Can be mounted vertically and horizontally
- Elevates your space with its modern appearance
- Universal design accommodates all glove brands
- Able to be mounted with supplied adhesive strips or screws
- Overall Dimensions: 21" H X 10.2" W X 3.5" D
- Overall Weight: 2.4 lb



Mounting Hardware Included



**CLEAR**  
ADI902-04



**BLACK**  
ADI902-04-BLK

74

# SHARPS & NEEDLE DISPOSAL CONTAINERS



# SHARPS AND NEEDLE DISPOSAL CONTAINER

1 Quart

- Dimensions Per Container: 6" H X 4.3" W X 4" D
- Weight Per Container: 0.19 lb

- Designed to be puncture resistant
- Made from robust, heat-resistant PP material
- Features a split-lid design and dual openings
- Temporary closure and snap locks provide ultimate protection
- Crafted with a transparent lid to see the filling progress

1-Pack

ADI998-01-01



3-Pack

ADI998-01-03



6-Pack

ADI998-01-06



## SPLIT-LID DESIGN



## SHARPS CONTAINER WITH MAILBOX-STYLE HORIZONTAL LID

5 Quarts

- Dimensions Per Container: 11" H X 10.6" W X 4.5" D
- Weight Per Container: 0.66 lb

- Designed to be puncture resistant
- Made from robust, heat-resistant PP material
- Mailbox-style lid allows the disposal of needles without direct contact
- Crafted with a transparent lid to see the filling progress
- Outfitted with locks to ensure safe transportation and sharps disposal



LID OPENING

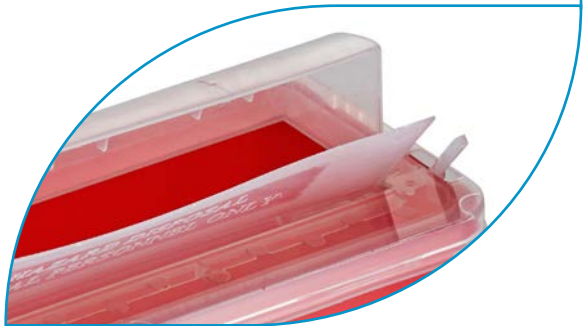

1-Pack

ADI998-02-01



2-Pack

ADI998-02-02



# SHARPS CONTAINER WITH FLIP-OPEN LID

8 Quarts

- Dimensions Per Container: 9.8" H X 8.2" W X 7" D
- Weight Per Container: 0.73 lb

- Features a flip-open lid design
- Designed to be puncture resistant
- Made from robust, heat-resistant PP material
- Crafted with a transparent lid to see the filling progress
- Accommodates larger syringes and has a significant holding capacity

1-Pack

ADI998-03-01



2-Pack

ADI998-03-02



FLIP-OPEN LID DESIGN



# SHARPS SHUTTLE CONTAINER

## With Locking Mechanism

- Dimensions Per Container: 6.5" H X 1.2" D
- Total Weight: 0.26 lb

- Designed to be puncture resistant
- Made from robust, heat-resistant PP material
- Allows for one-handed operation
- Cap is specifically designed to be leak-resistant, providing secure containment
- Convenient size easily fits into bags for EMS, Fire and Rescue, and Nursing

6-Pack

ADI998-04-06



### LEAK-RESISTANT CAP





# SHARPS CONTAINER ROUND SHAPED

1.5 Quarts

- Dimensions Per Container: 6" H X 5.5" W X 4.3" D
- Weight Per Container: 0.25 lb

- Designed to be puncture resistant
- Made from robust, heat-resistant PP material
- Outfitted with protective plastic liner and tie
- Crafted with a transparent lid to see the filling progress
- Attached cover ensures contents stay safely inside the container

1-Pack

ADI998-05-01



2-Pack

ADI998-05-02



## SAFETY



Outfitted cover ensures that the contents stay safely inside the container

80

# PILL CRUSHER



## PILL CRUSHER

- Overall Dimensions: 11.42" L x 4.33" W x 3.15" H
- Weight: 3.30 lb

- Designed to help streamline the medication administration process
- It can be used for a wide range of medications, making it a useful tool in any healthcare setting



# ADIME950-01

## PILL POUCH

### For AdirMed Pill Crusher

- Clear plastic pouches help to ensure that the crushing process is hygienic, reducing the risk of contamination



- Overall Pouch dimensions: 3.94" x 1.97"
- Quantity: 1,000 pouches

# ADIME950-02



# EXAM ROOM PACKAGES





## VIVA COMFORT EXAM ROOM PACKAGE

Ready with everything you need

### *Available items:*

- **Exam Table**  
*Your choice of model and upholstery color*
- **Exam Stool**  
*Your choice of model and upholstery color*
- **Medical Scale**  
*Digital, beam, wheelchair or handrail scale*
- **Wall Cabinet**  
*36-Inch or 48-Inch size*
- **Base Cabinet**  
*36-Inch or 48-Inch size*
- **Acrylic Gloves Dispenser**  
*Your choice of capacity*
- **Soap & Hand Sanitizer Dispenser**  
*ALP425-WHI, ALP423-SSB or ALP424-SSB*
- **Multifold Paper Towel Dispenser**  
*ALP480, ALP481, ALP481-S or ALP454-ECO-TBLK*
- **Stainless Steel Trash Can**  
*ALP470-65, ALP470-65L, ALP470-10L, ALP470-20L, ALP470-40L, ALP470-R-40L*

**84** CUSTOMIZE AN EXAM ROOM PACKAGE THAT BEST FITS YOUR NEEDS WITH THE BELOW PRODUCTS:

Choose your **EXAM TABLE**



**Grande Steel Exam Table**



**Noble-Line Exam Table**

Choose your **EXAM STOOL**



**Luxe Exam Stool**



**Pneumatic Height Adjustable Exam Stool**

Choose your **MEDICAL SCALE**



**Digital**



**Beam**



**Wheelchair**



**Handrail**

Choose your **WALL CABINET**



**36-Inch Wall Cabinet**



**48-Inch Wall Cabinet**

Choose your **BASE CABINET**



**36-Inch Base Cabinet**



**48-Inch Base Cabinet**

- Left Sink
- Right Sink
- No Sink

Choose your **GLOVE DISPENSER**



**Single Box**



**Double Box**

Choose your **SOAP DISPENSER**



**White**



**Stainless Steel Vertical**



**Stainless Steel Horizontal**

Choose your **STEEL TRASH CAN**



**17 Gallon**



**34 Gallon**

Choose your **PAPER TOWEL DISPENSER**



**C-Fold / Multi-Fold**



**C-Fold / Multi-Fold**



**C-Fold / Multi-Fold**



**Roll Paper**



**2.7 Gallon**



**5.2 Gallon**



**10.5 Gallon**



**10.5 Gallon**

*Dual Compartment*

# CONTACT INFORMATION

 Monday - Thursday: 9:00am - 5:30pm EST / Friday: 9:00am - 3:00pm EST

 800.292.6277

 [cs@vivacomfort.com](mailto:cs@vivacomfort.com)



Scan Our QR Code To  
Check Out Our Website

© 2024 Viva Comfort. All Rights Reserved.

Manufacturer reserves its right to change technical specification and configuration of the equipment in the course of its further development.

